

FORMULA 108/17 H > 13AD799G637 (2008) > DEFLEKTOR

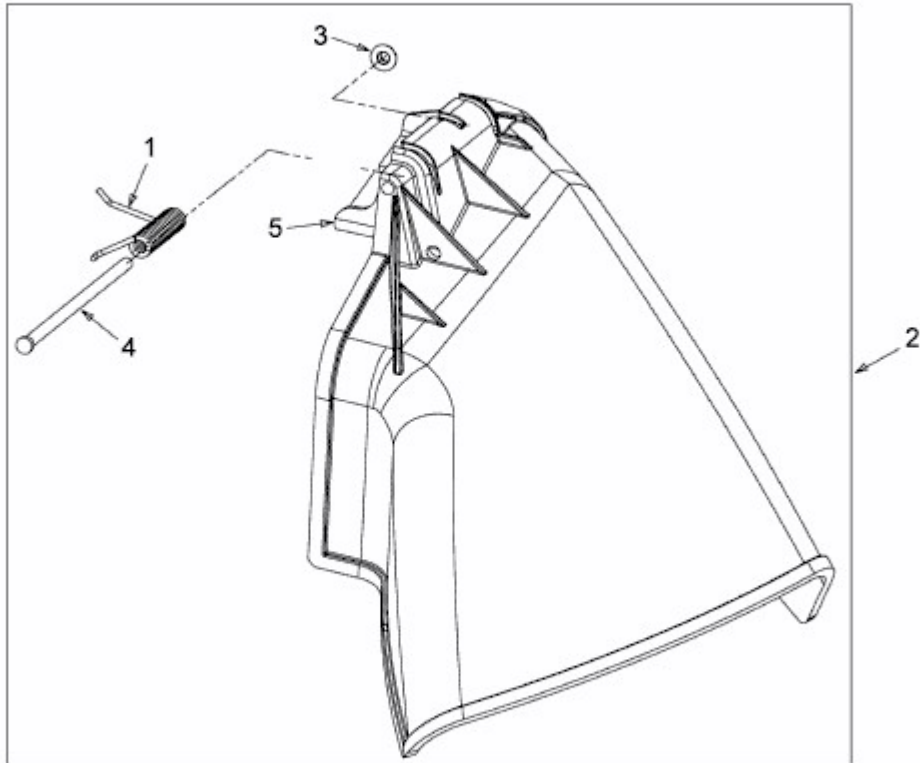

E3-02744A-01