

FORMULA 108/17 H > 13AD799G637 (2008) > HYDROSTAT

618-04198  
348-0510

Nicht abgebildet/ Not Shown	
SEALANT	6
SEAL AND O-RING KIT	127

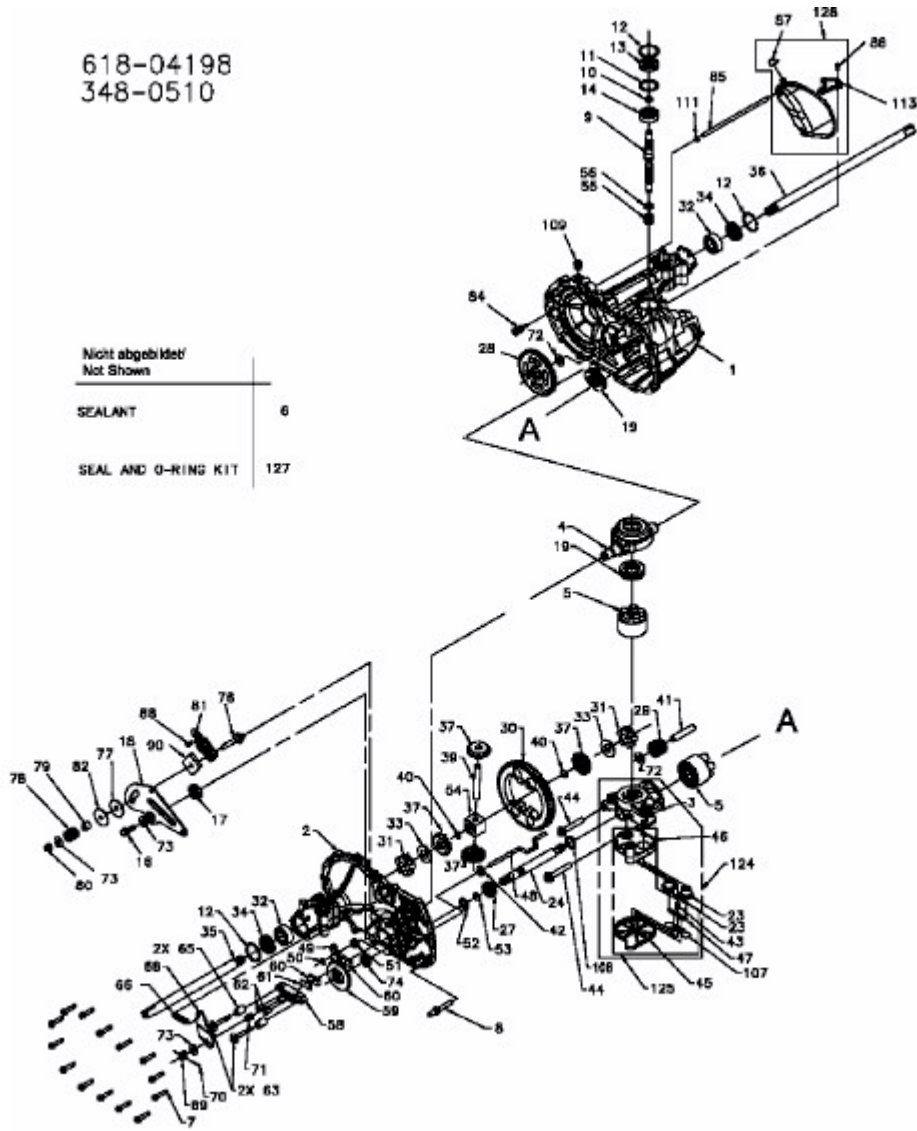

E3-02748A-01