

FORMULA 108/17 H > 13AD799G637 (2008) > TRITTBRETTBELAG

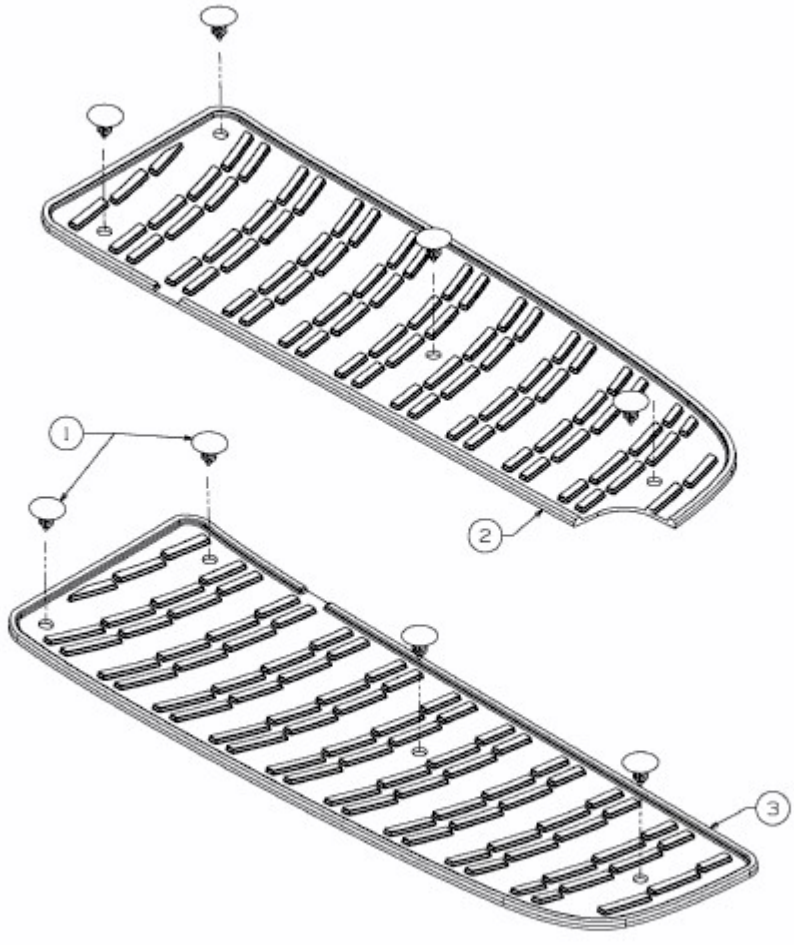

E3-02722B-01