

FORMULA 108/17 H > 13AD799G637 (2008) > LENKRAD

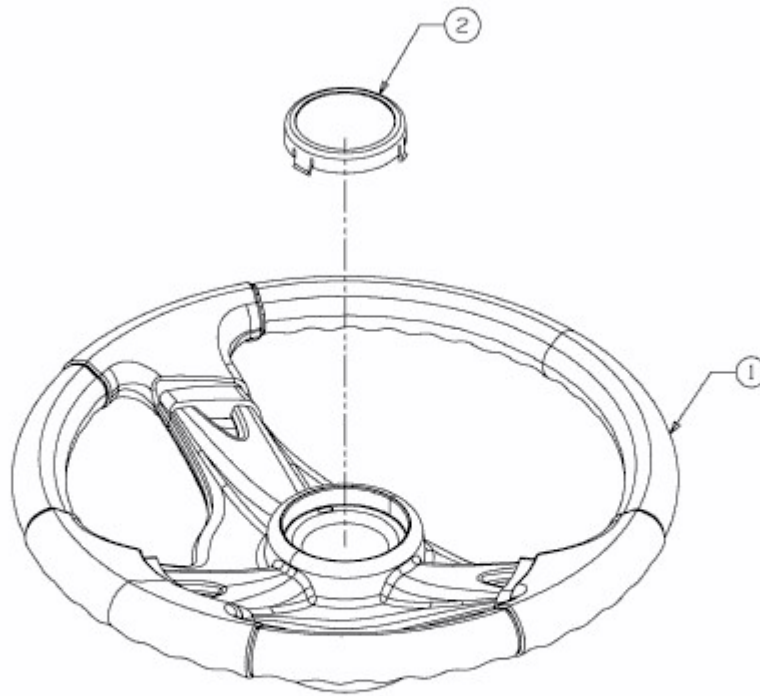

E3-02015A-01