

FORMULA 108/17 H > 13AD799G437 (2008) > MOTORHAUBE 9-STYLE

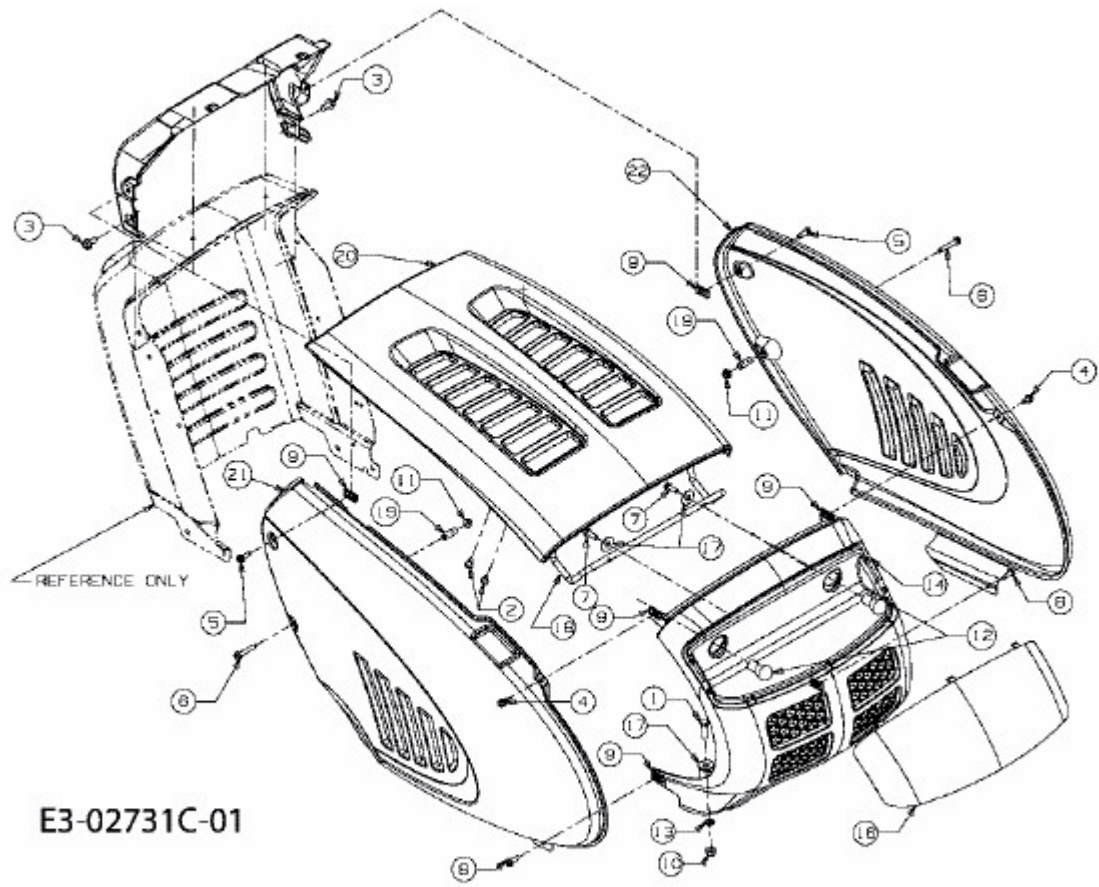

E3-02731C-01