

ZG 6170 > 13AD624G643 (2002) > ELEKTROMAGNETKUPPLUNG, MÄHWERKSANTRIEB, RAHMEN

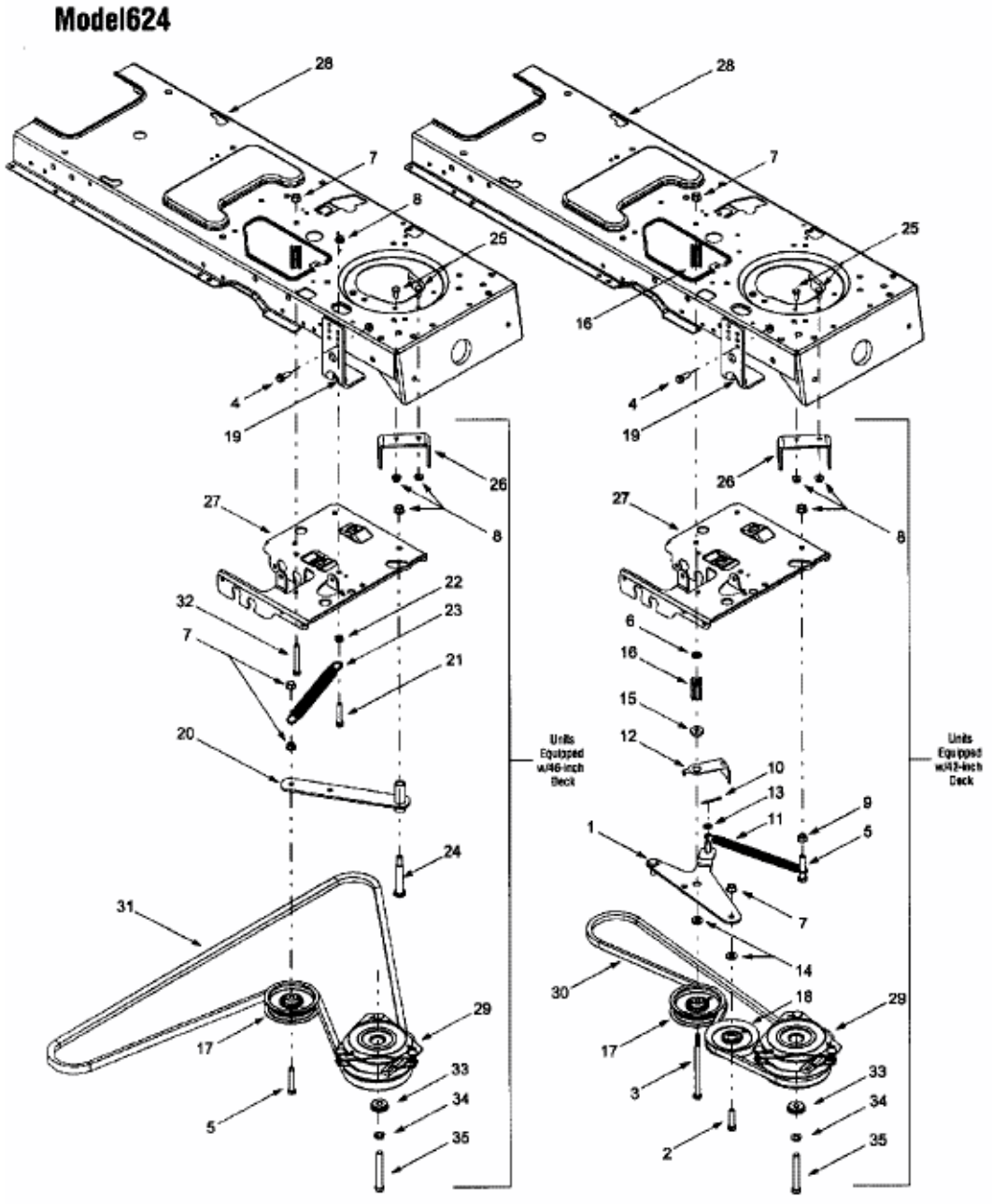

E4-00975 A-1