

SG 175 H > 13AD518G678 (2003) > BATTERIE

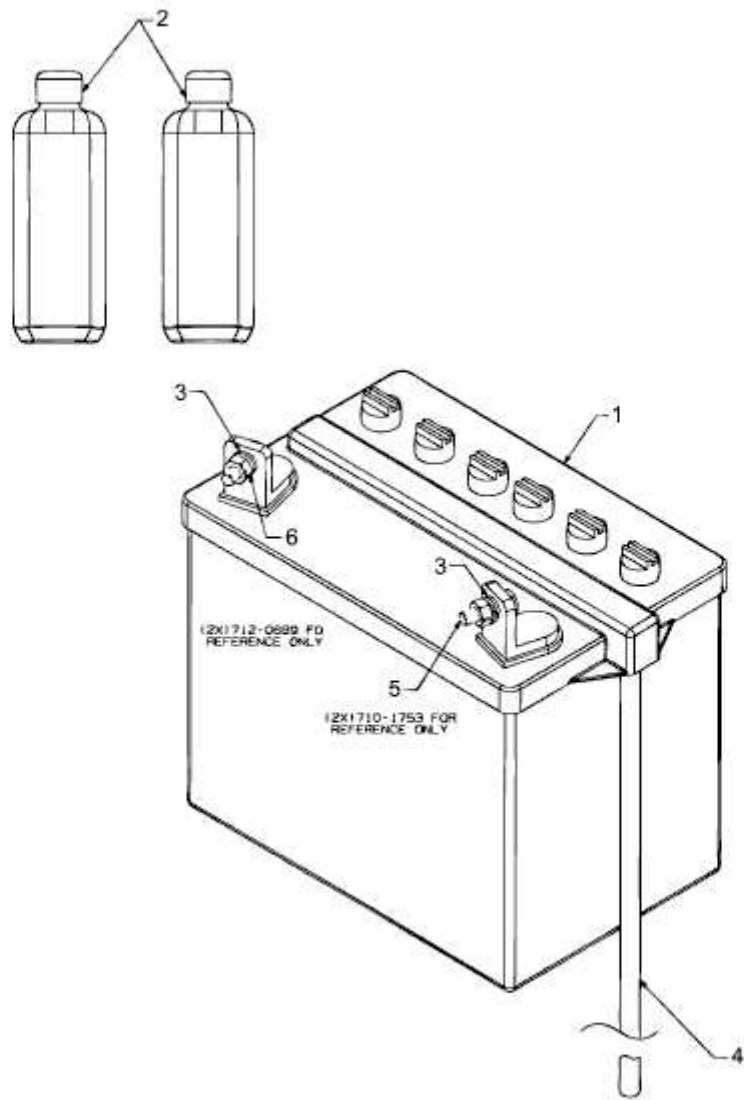

E3-07963A-01