

SG 175 H > 13AD518G678 (2003) > MÄHWERKSEINSCHALTUNG

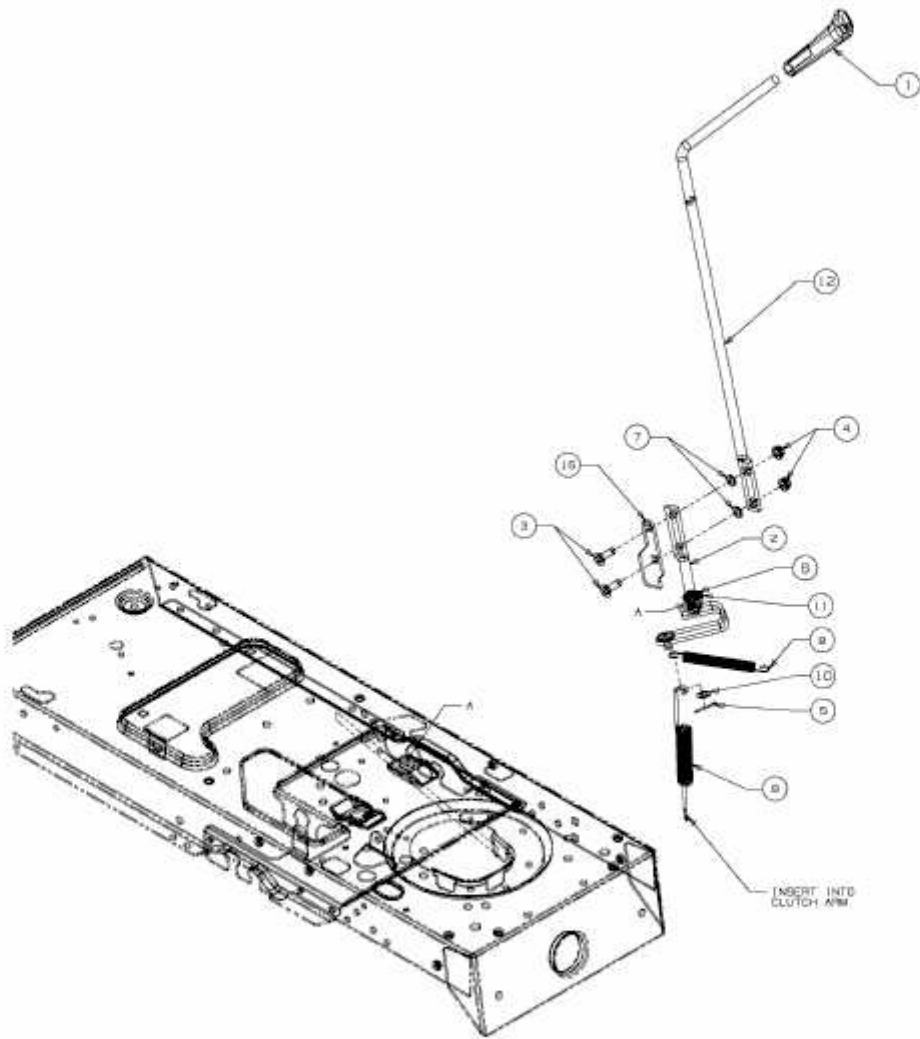

E3-01676A-02