

SG 175 H > 13AD518G678 (2003) > LENKRAD

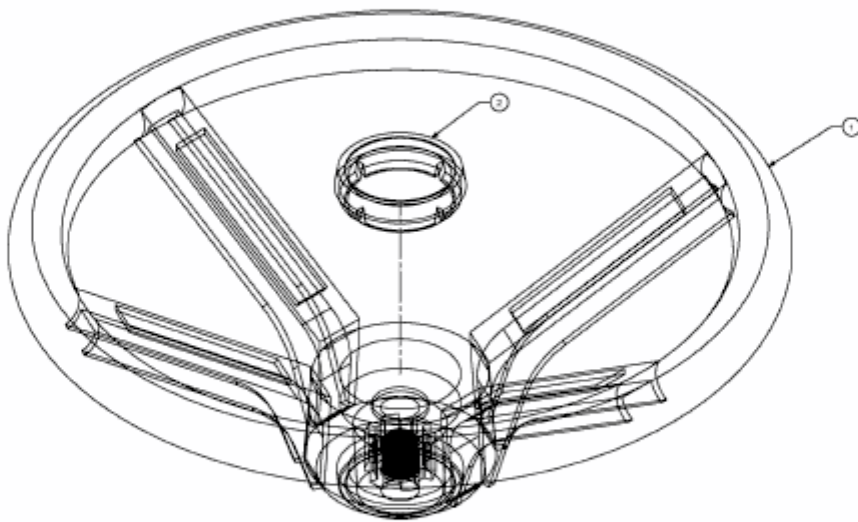

E3-07958A-01