

EDT 115-76 > 13AC452C610 (1998) > FAHRANTRIEB, MOTORKEILRIEMENSCHLEIBE, PEDAL, RÄDER HINTEN

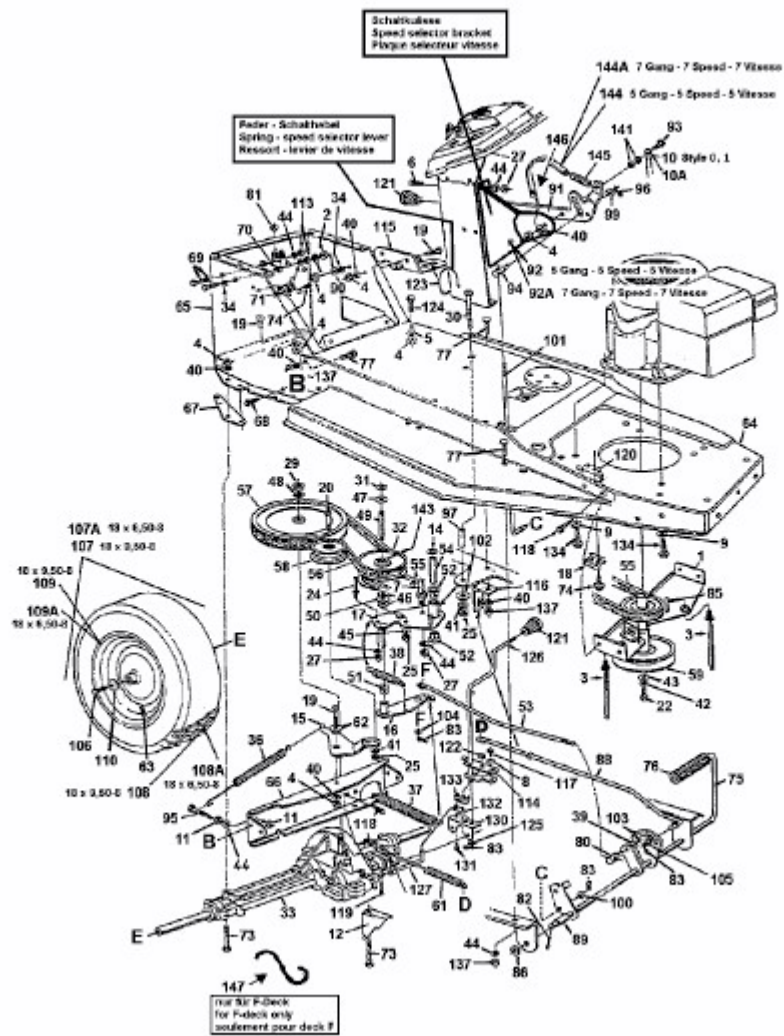

E4-00590A-01

Fig