

AMH 1152 > 13AB459A619 (2002) > GETRIEBE

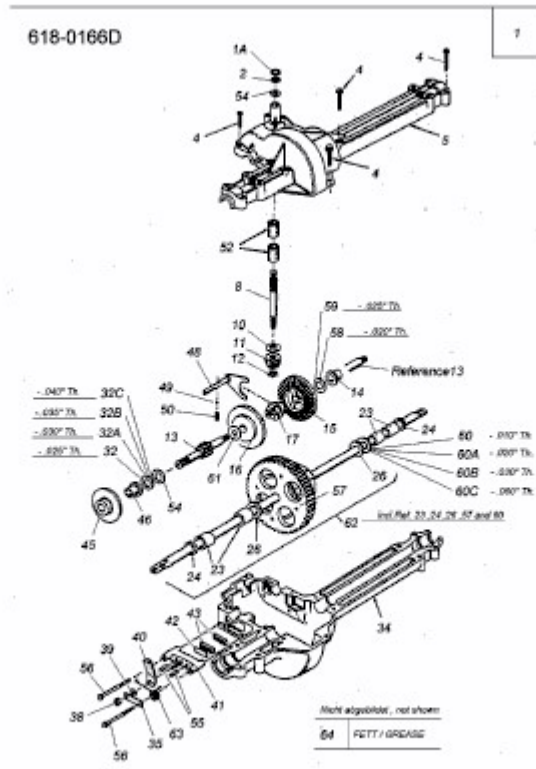

E3-01304B-01