

AMH 1151 > 13AB453C619 (2003) > GRASFANGKORB

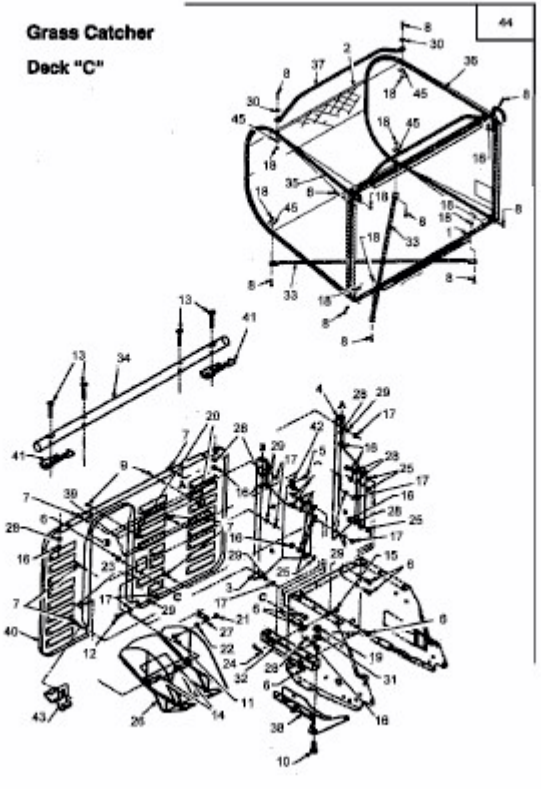

E3-01302B-01