

AMH 1151 > 13AB453C619 (2000) > GETRIEBE

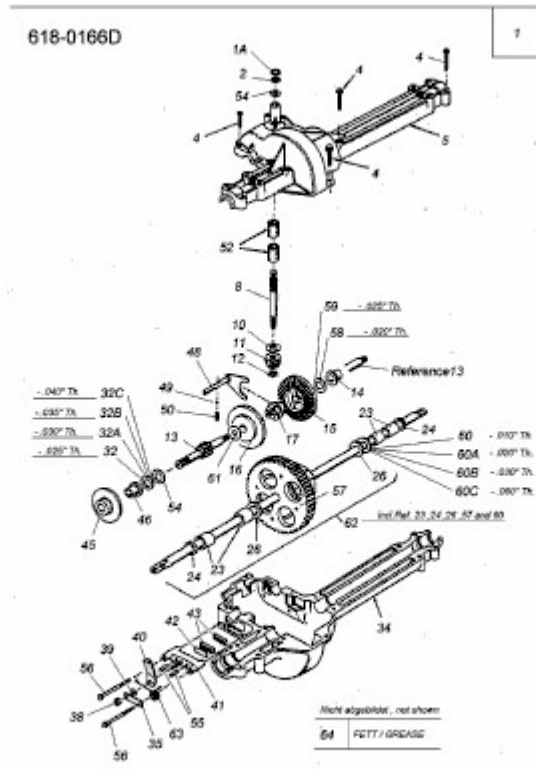

E3-01304B-01