

AMH 1151 > 13AB453C619 (1999) > GETRIEBE

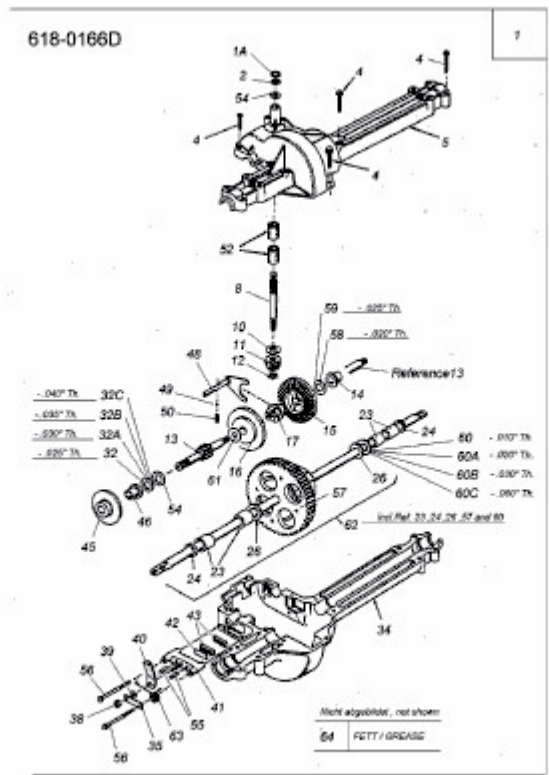

E3-01304B-01