

ab 23/07/2018
from 07/23/2018
à partir du 23/07/2018

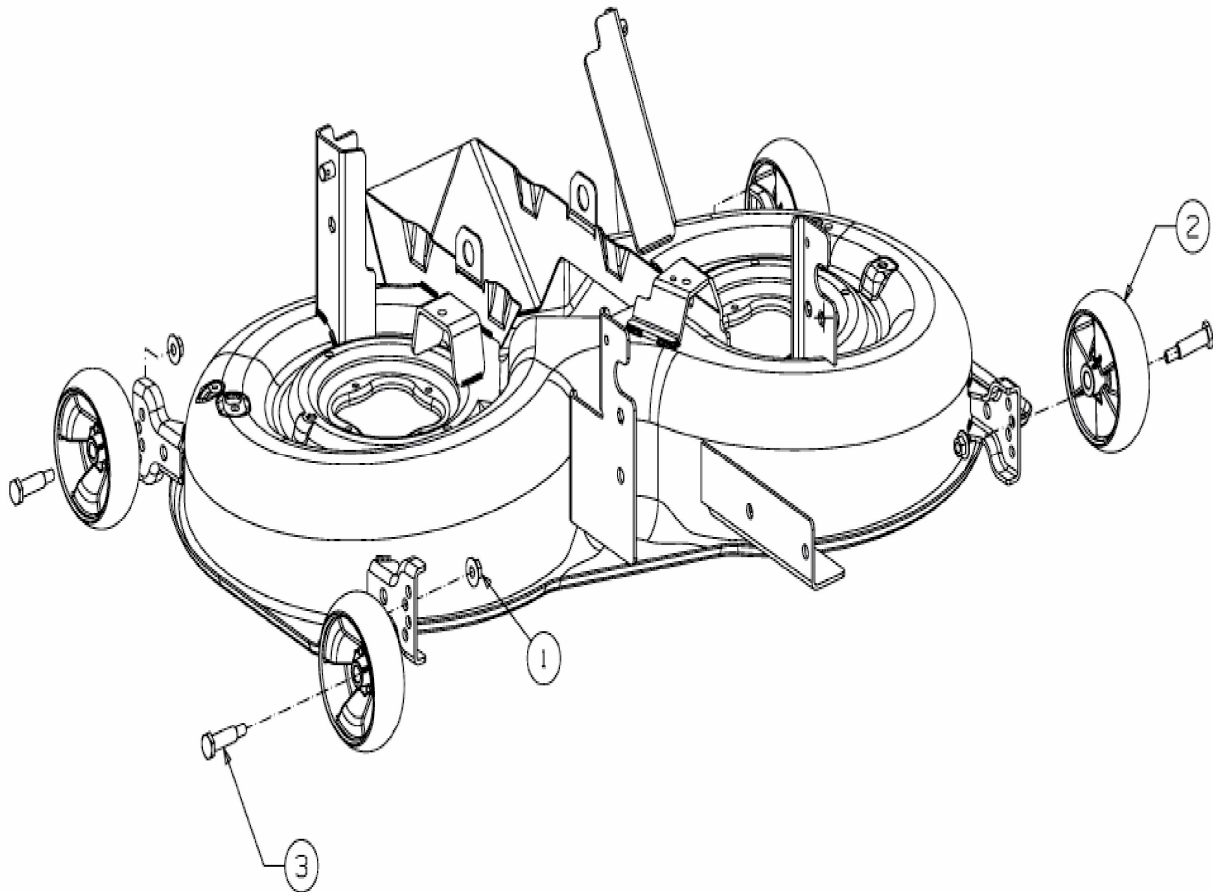

E3-10672A-01