

TA 4130 > 13AA474A643 (2002) > GRASFANGKORB

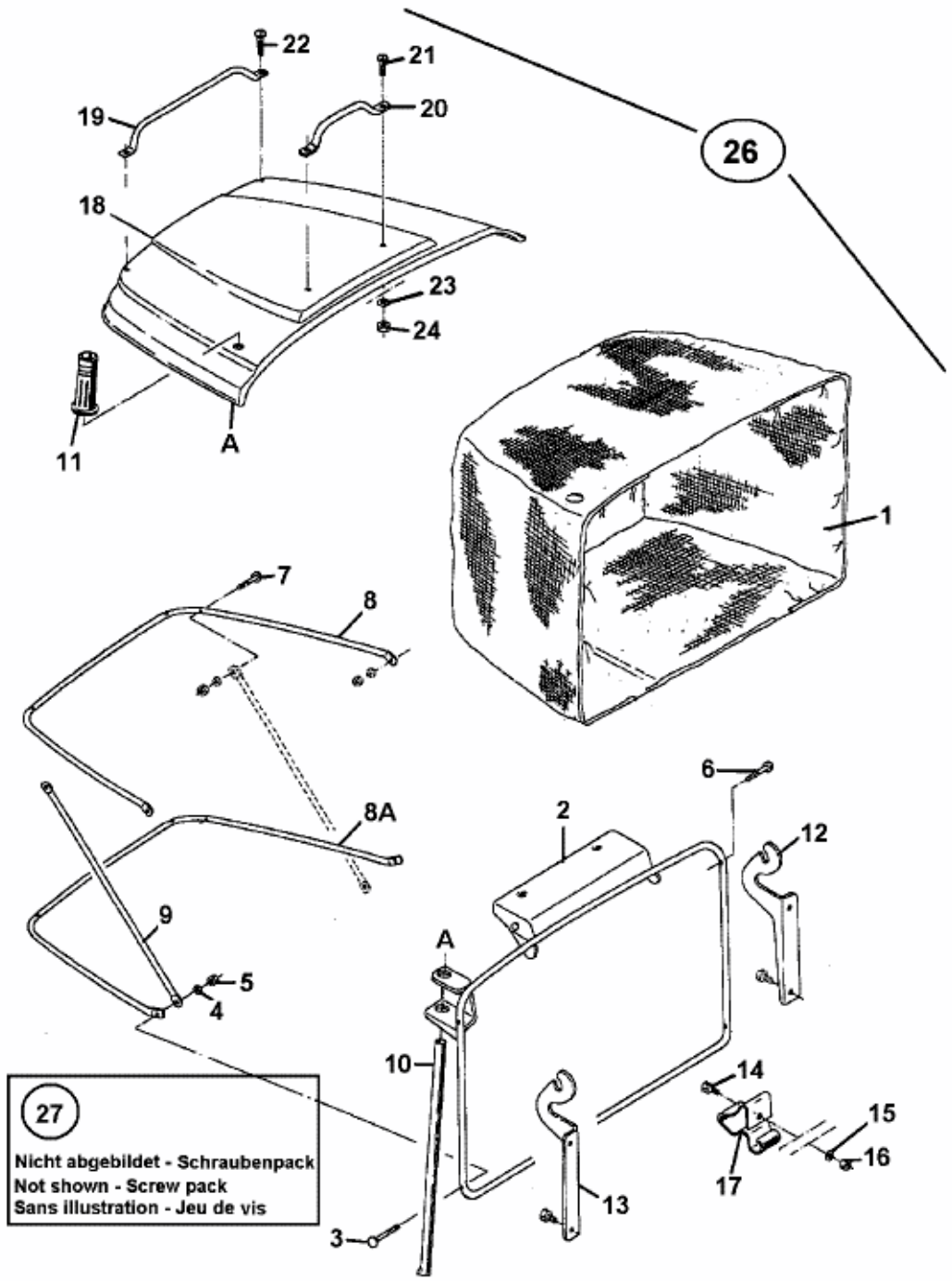

fig

E3-01389A-01