

13A951CN603 (2007) > FÜLLSTANDSANZEIGE

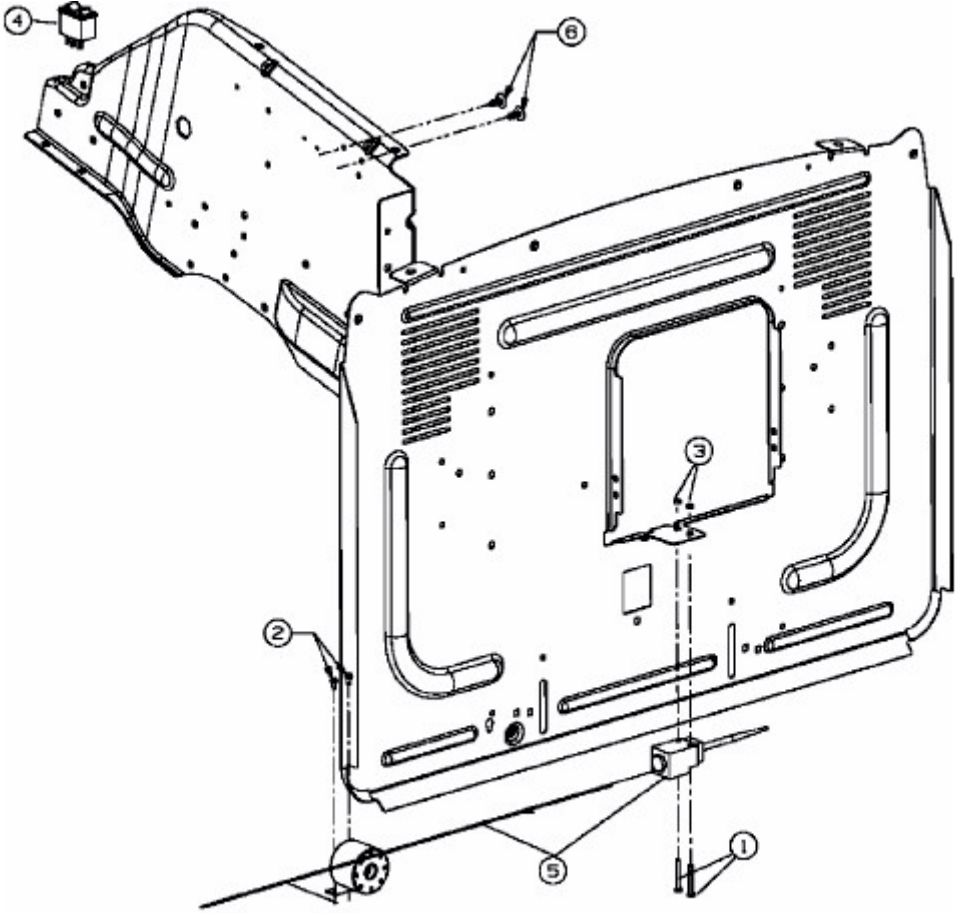

E3-03432A-01