

ab 13.02.2017
from 13.02.2017
à partir du 13.02.2017

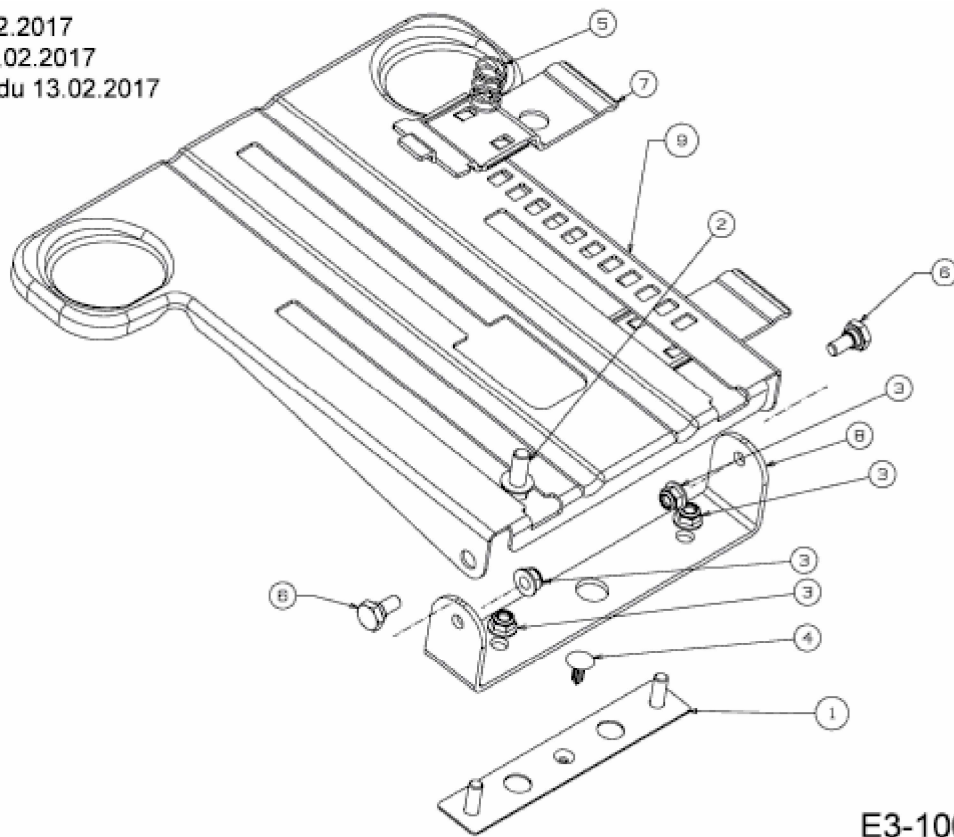

E3-10076A-02