

SILVERTRAC 20/107 T > 13A7763G477 (2006) > ARMATURENBRETT, CHOKEZUG, GASZUG, ZÜNDSCHLOSS

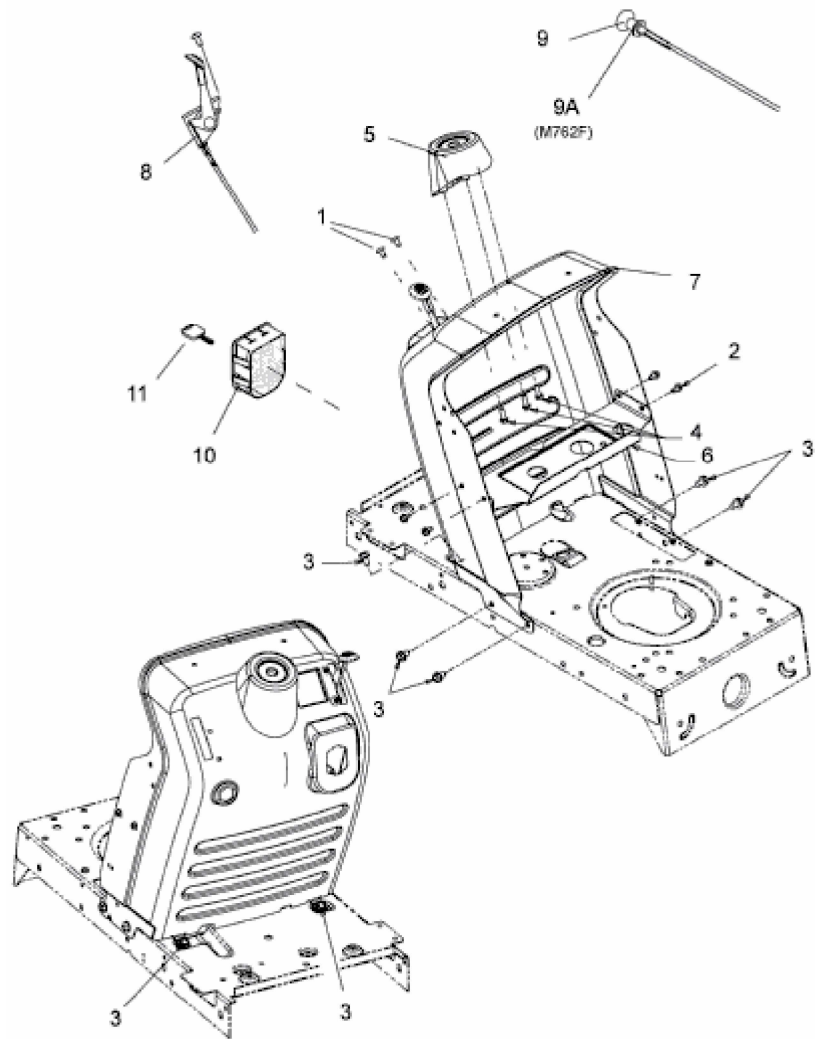

E3-02734A-01