

AMH 1651 > 13A5489N619 (2005) > ARMATURENBRETT

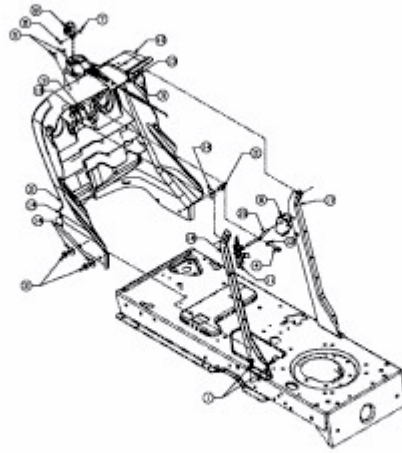

E3-02021A-01