

AMH 1651 > 13A5489N619 (2005) > MOTORKEILRIEMENSCHLEIBE

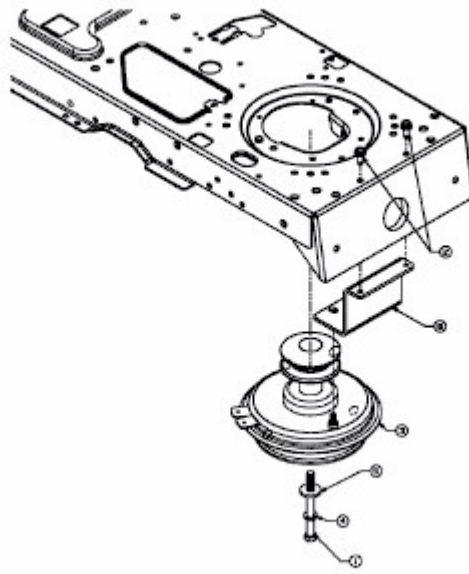

E3-02063A-01