

AMH 1651 > 13A5489N619 (2004) > PEDALE

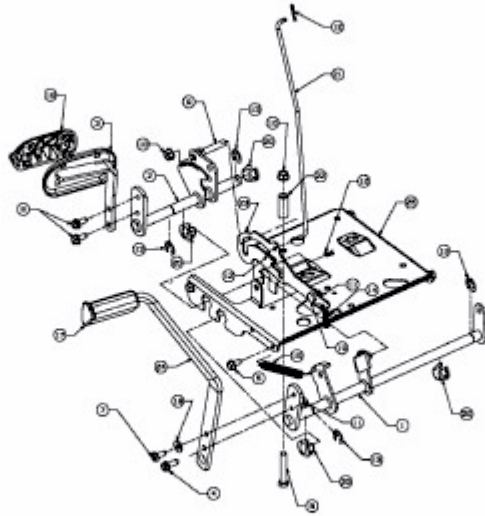

E3-02031A-01