

AMH 1651 > 13A5489N619 (2004) > RAHMEN

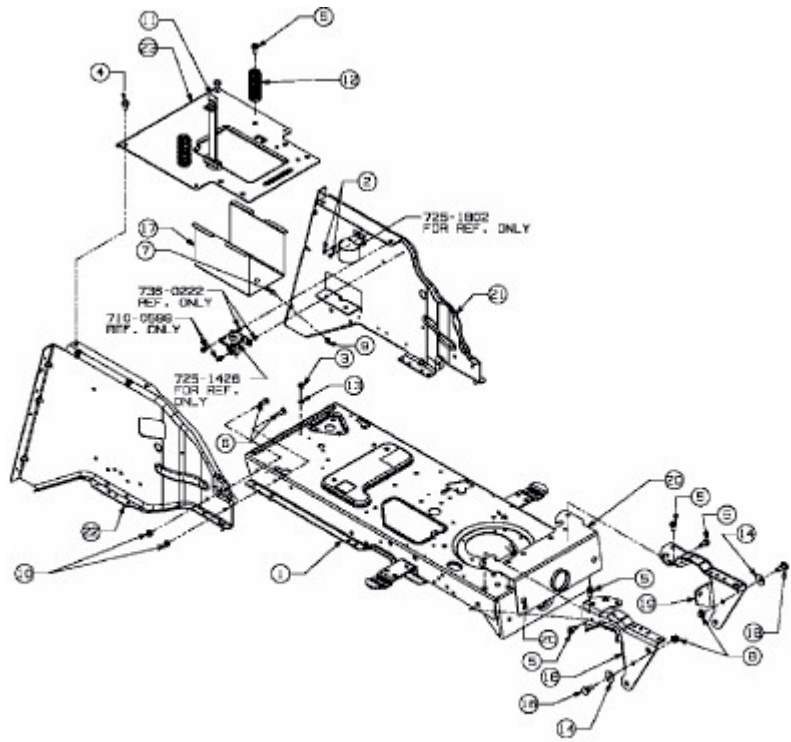

E3-02026A-01