

RS 220/107 > 13A4762G600 (2007) > GETRIEBE, VARIATOR

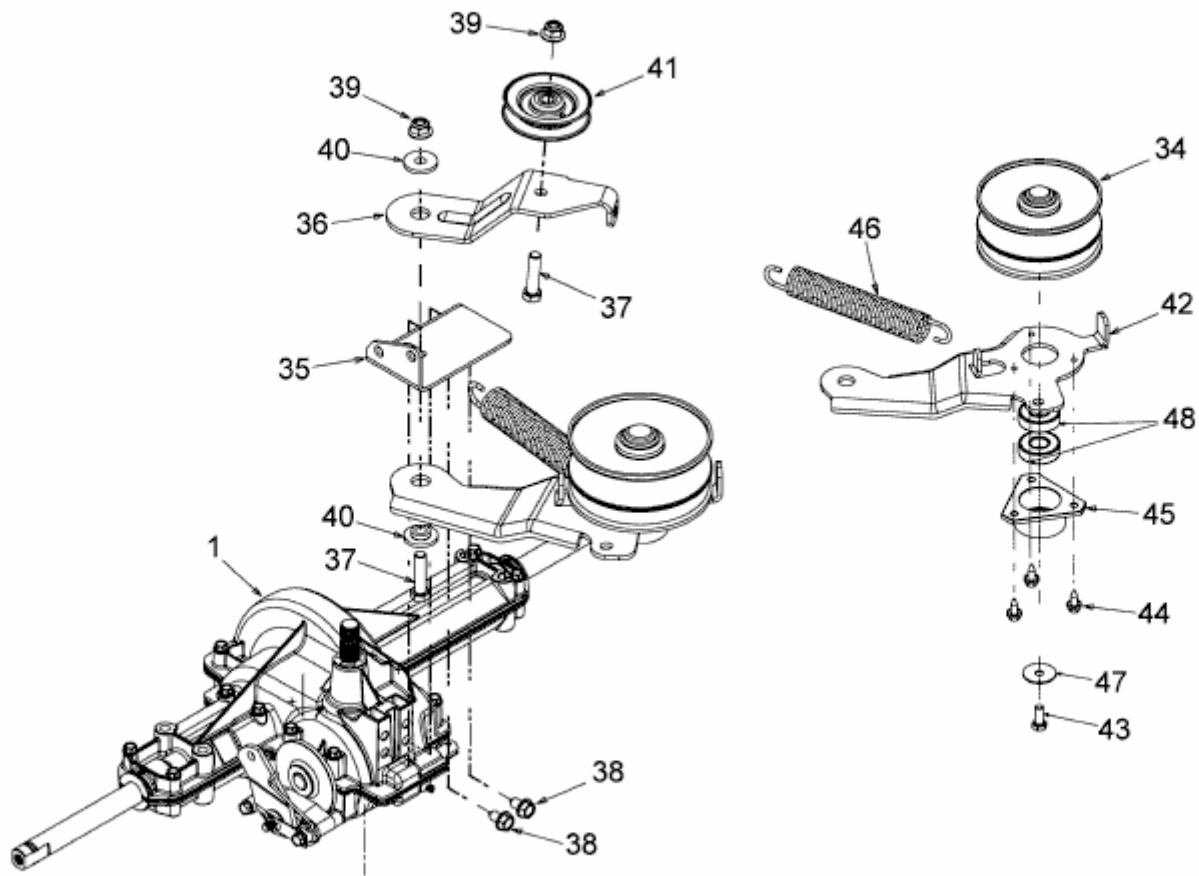

E3-02723B-02