

RS 220/107 > 13A4762G600 (2007) > GESCHWINDIGKEITSREGELUNG, PEDALE

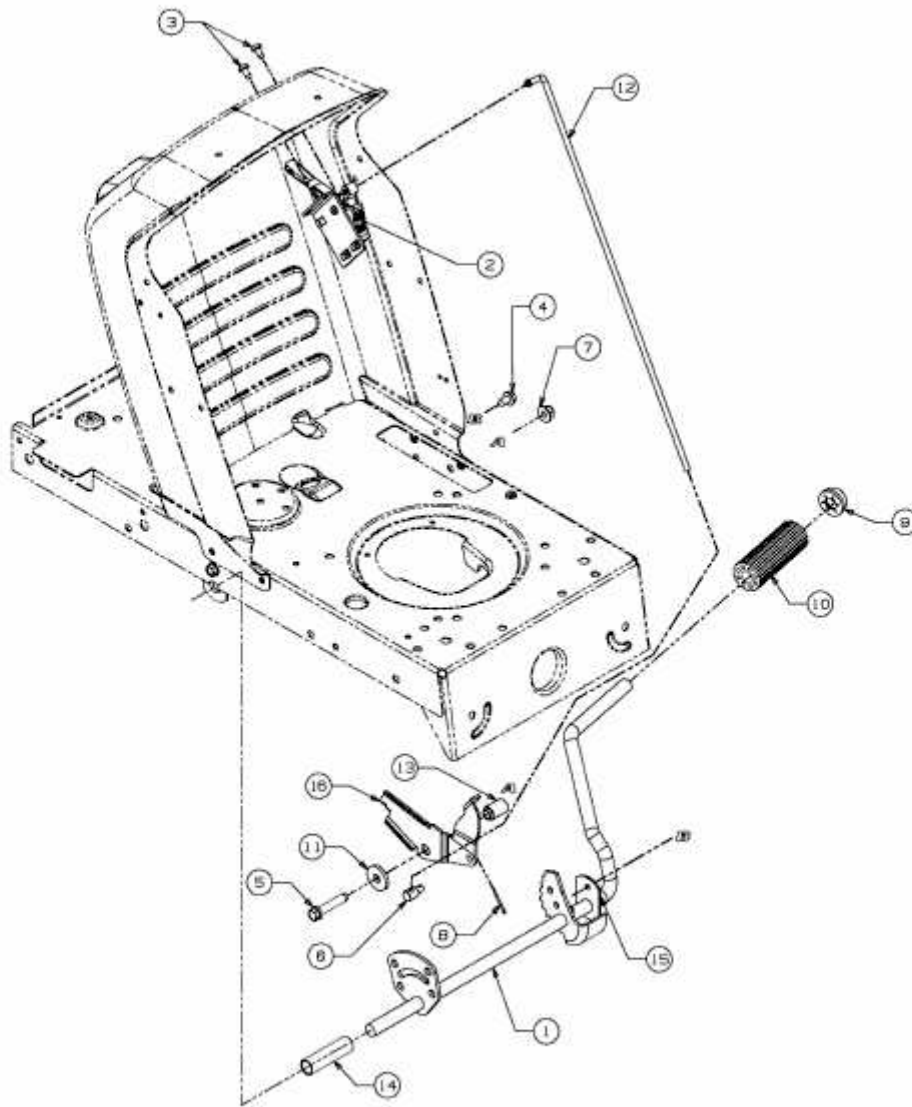

E3-02718A-01