

RS 180/107 > 13A3762G600 (2007) > FAHRANTRIEB, VARIATOR

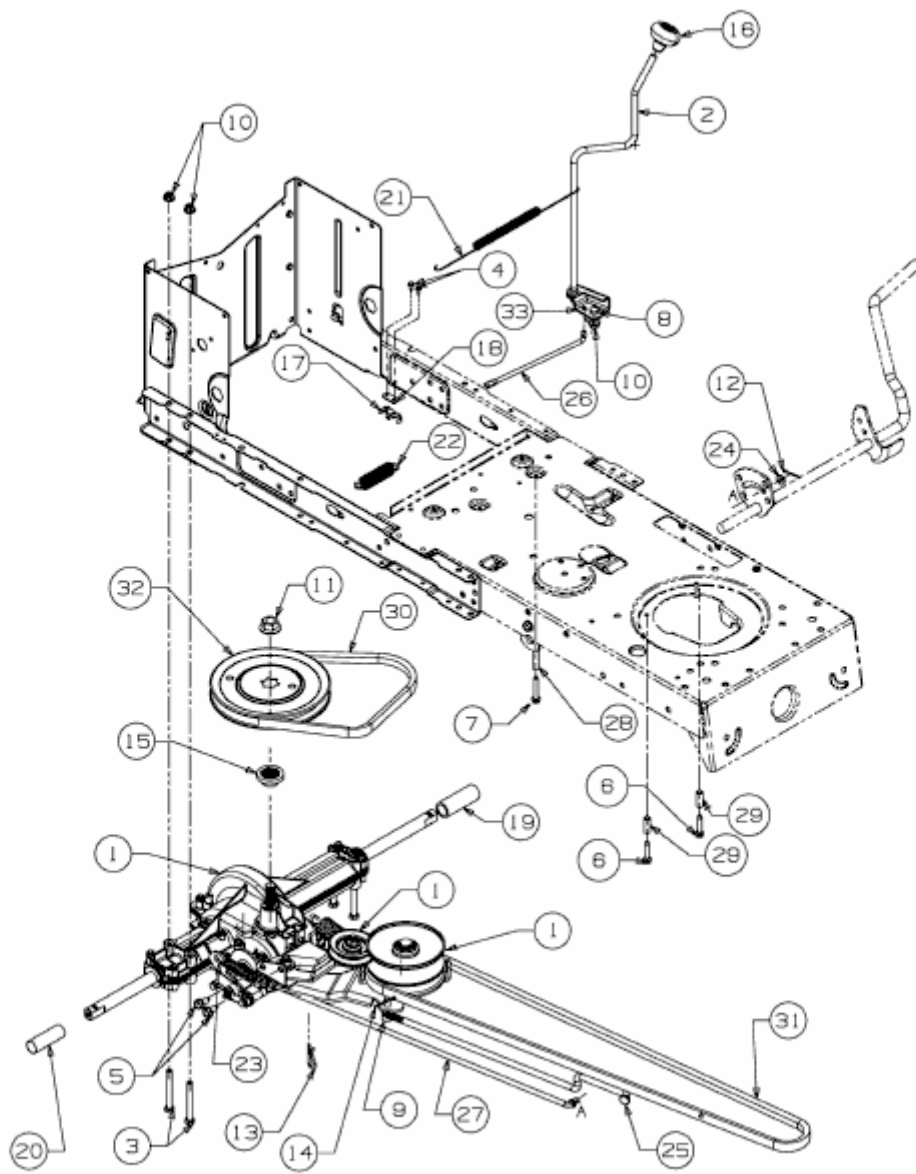

E3-02723B-01