

RS 180/107 > 13A3762G600 (2007) > GESCHWINDIGKEITSREGELUNG, PEDALE

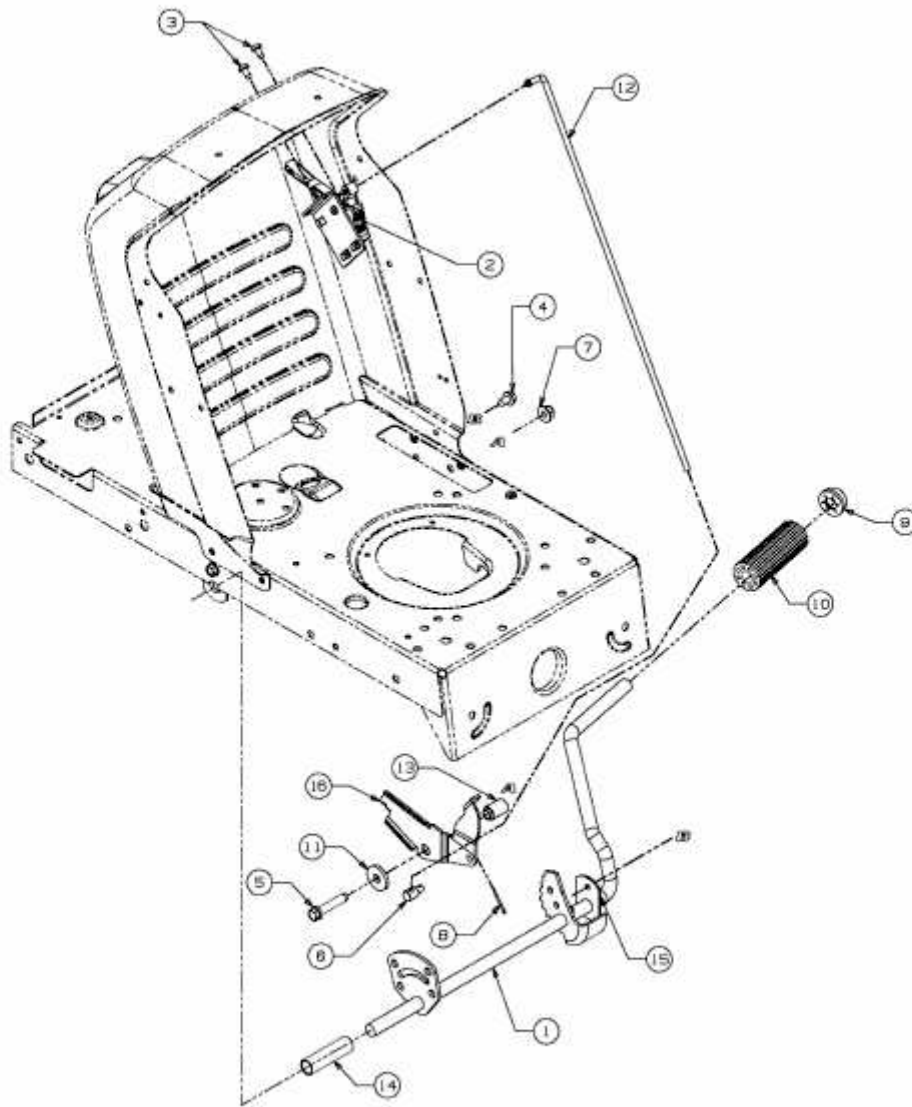

E3-02718A-01