

RS 180/107 > 13A3762G400 (2006) > GESCHWINDIGKEITSREGELUNG, PEDALE

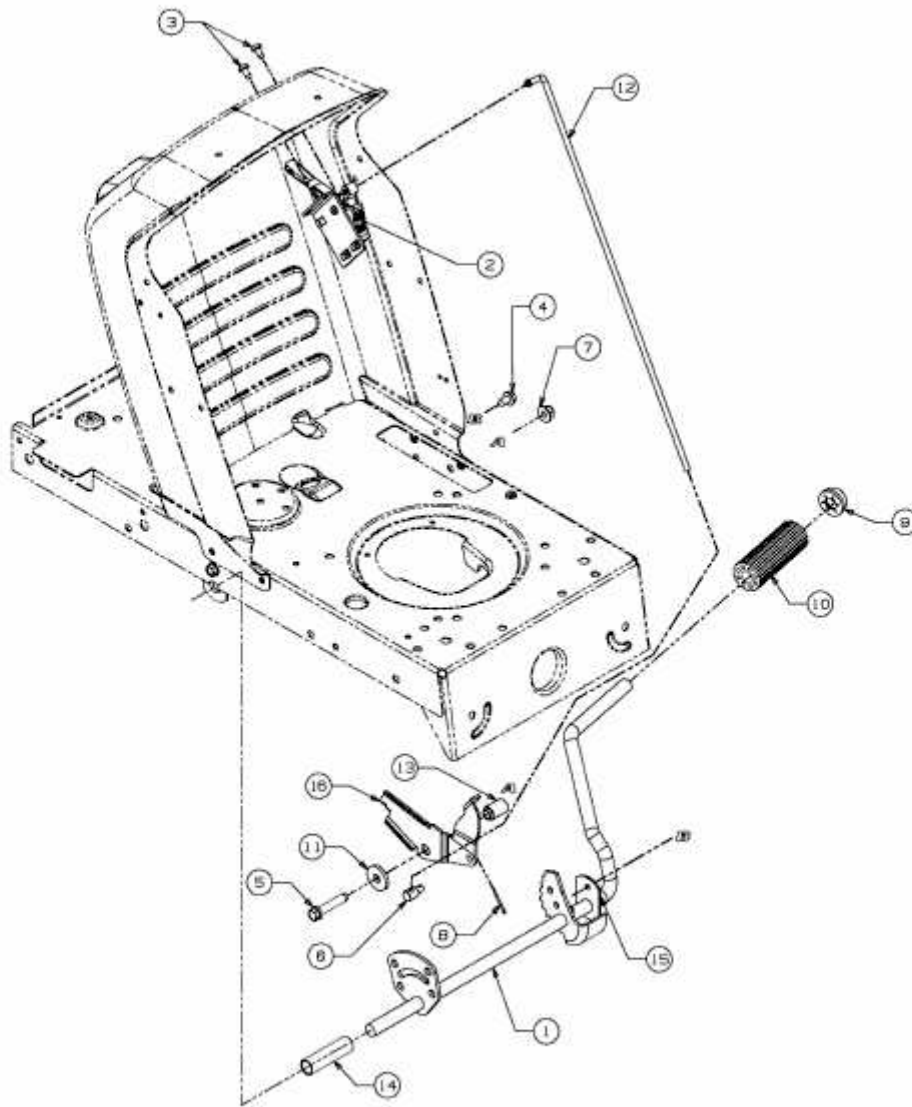

E3-02718A-01