

BL 175/107 T > 13A3761G684 (2007) > GESCHWINDIGKEITSREGELUNG, PEDALE

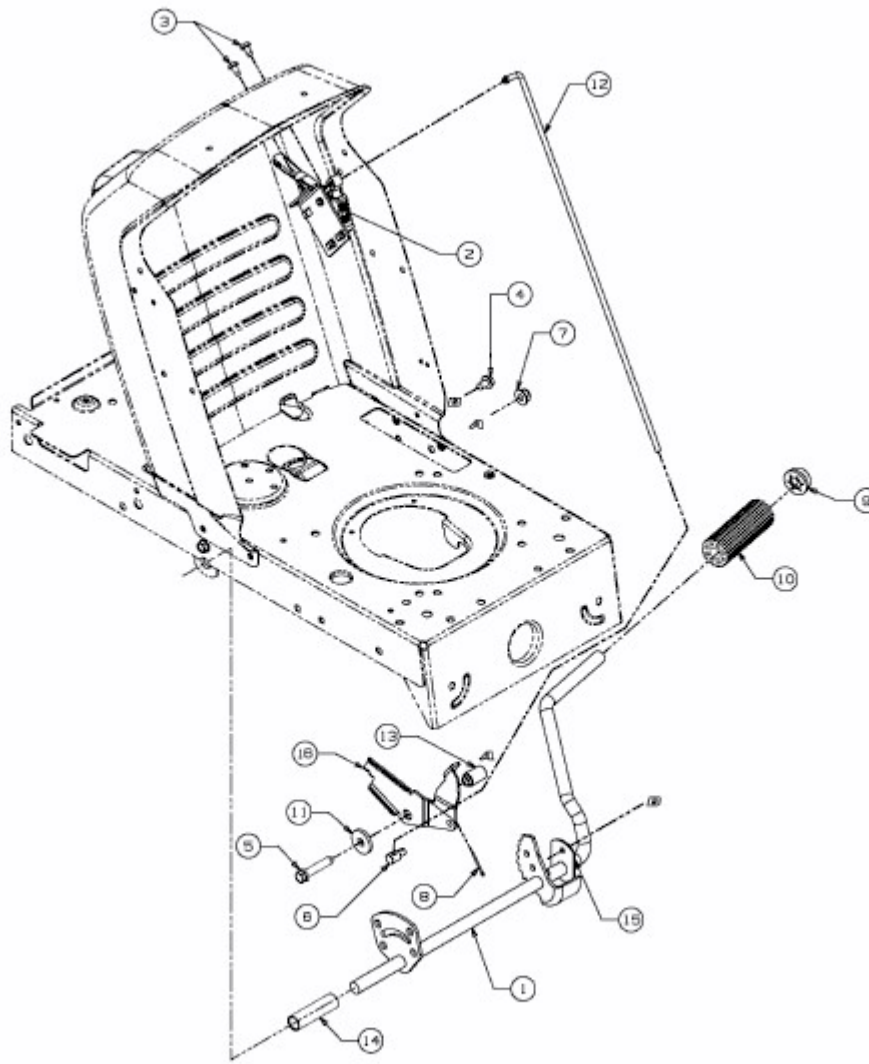

E3-02718A-01