

RH 150/105 > 13A3488N600 (2006) > HITZESCHUTZ

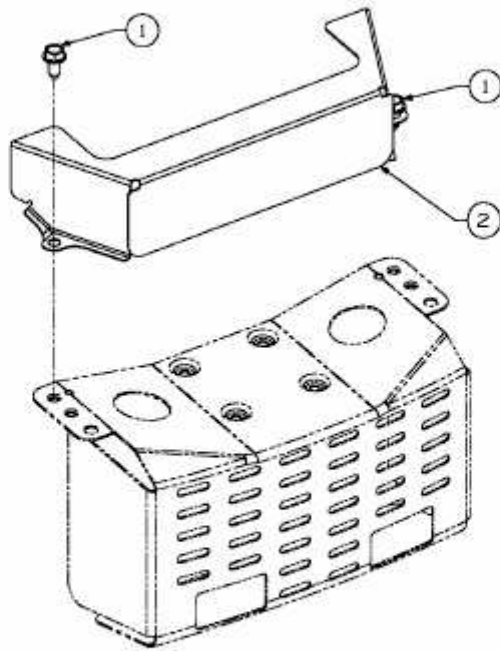

E3-02369A-01