

RH 150/105 > 13A3488N600 (2006) > SITZWANNE

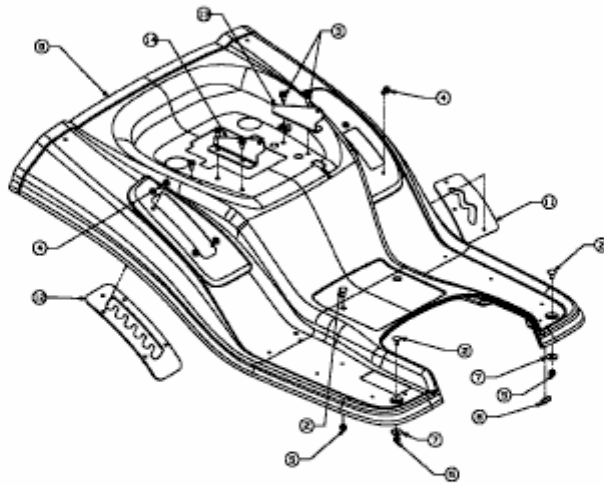

E3-02050A-01