

RH 150/105 > 13A3488N400 (2007) > HITZESCHUTZ

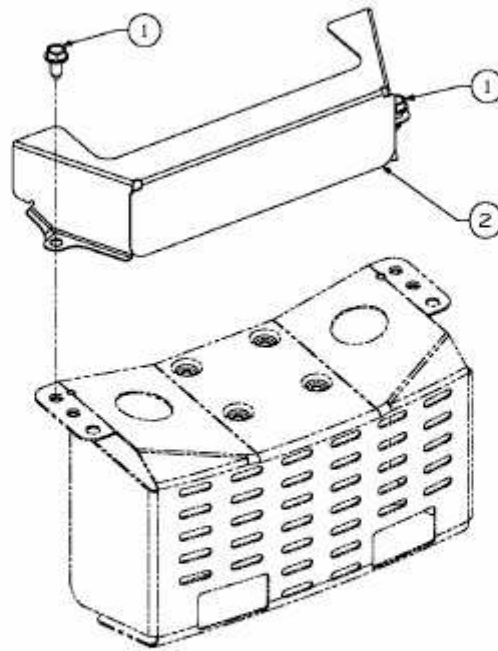

E3-02369A-01