

RH 150/105 > 13A3488N400 (2007) > RAHMEN

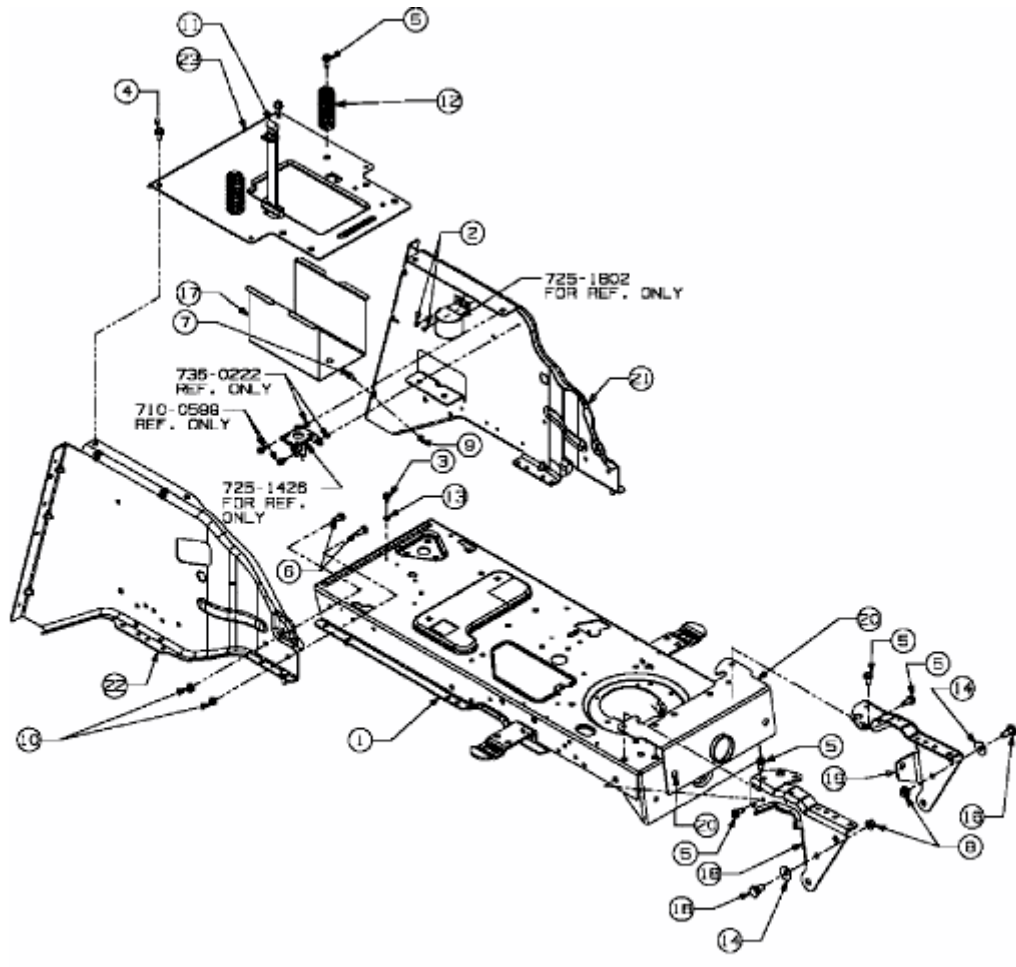

E3-02026A-01