

B 150/92 A > 13A3488E683 (2007) > RAHMEN

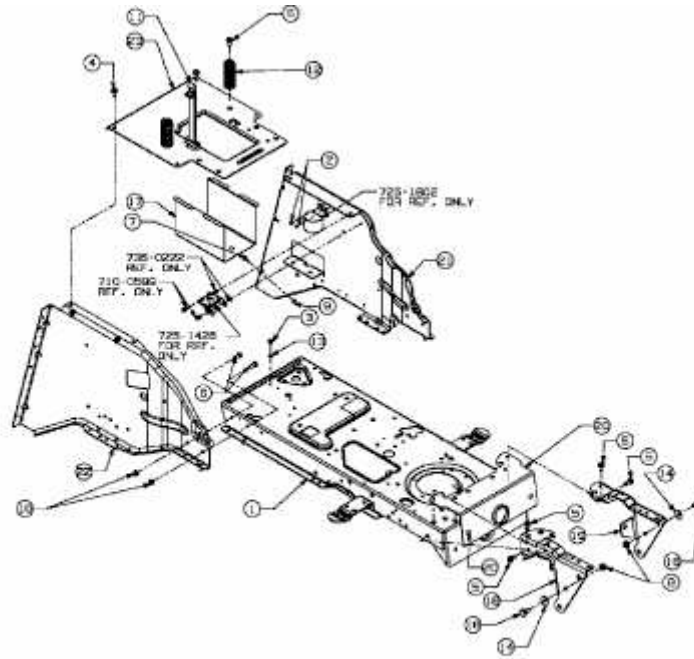

E3-02026A-01