

RH 155/92 T > 13A3458E678 (2003) > HECKPLATTE

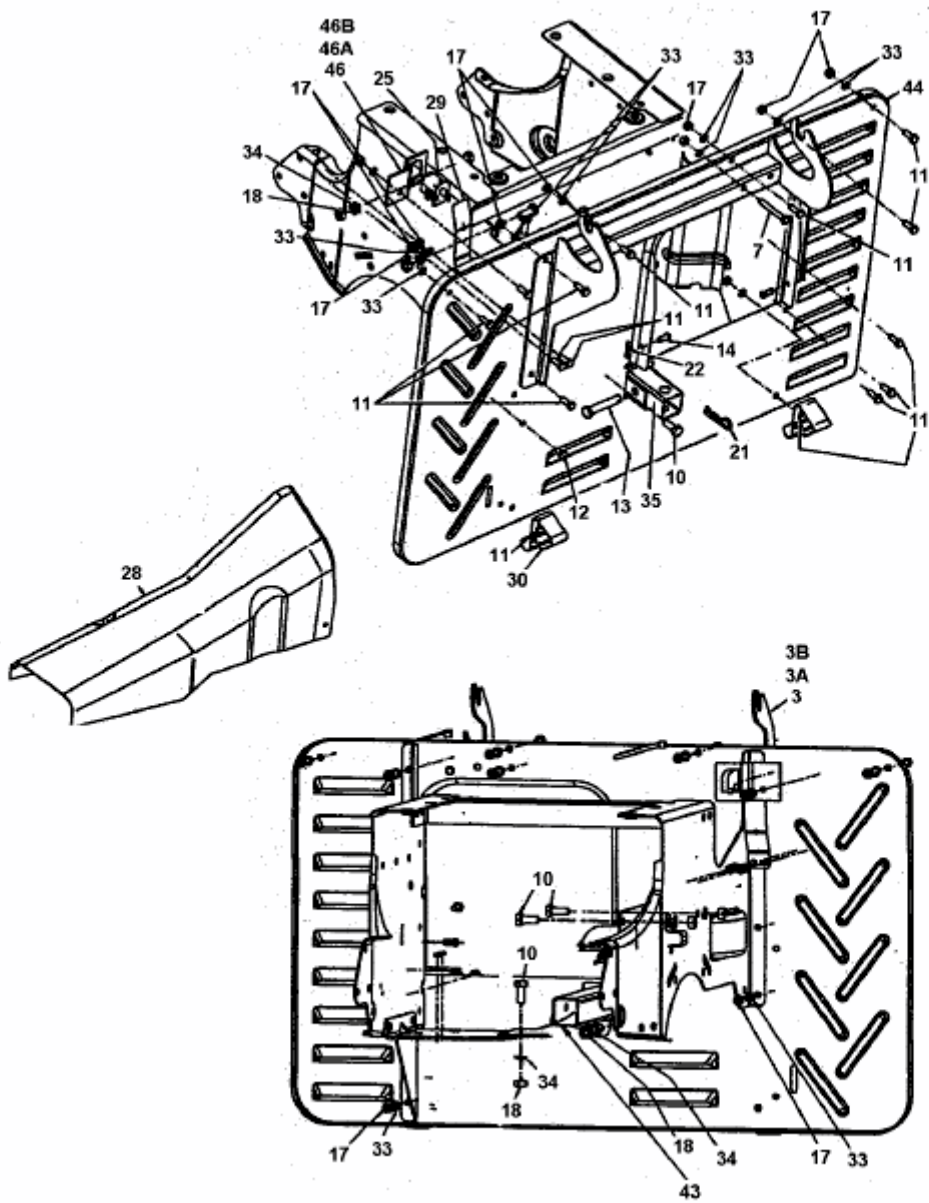

E3-01439A-02

Fig.