

RH 125/92 > 13A3458E600 (2003) > ARMATURENBRETT, SITZ, TANK

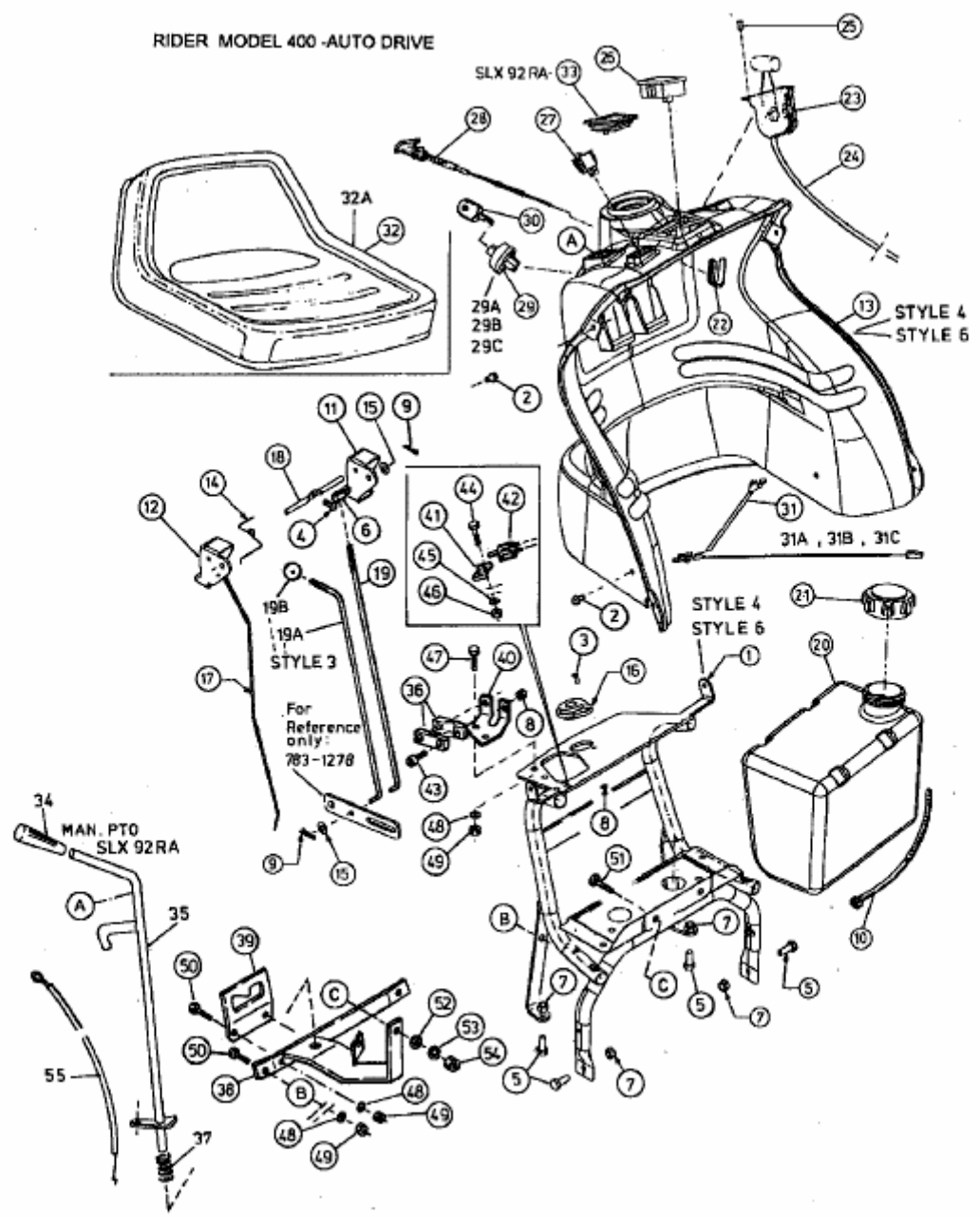

E3-01527 C