

B 125 > 13A3450F600 (2002) > MÄHWERKSAUSHEBUNG

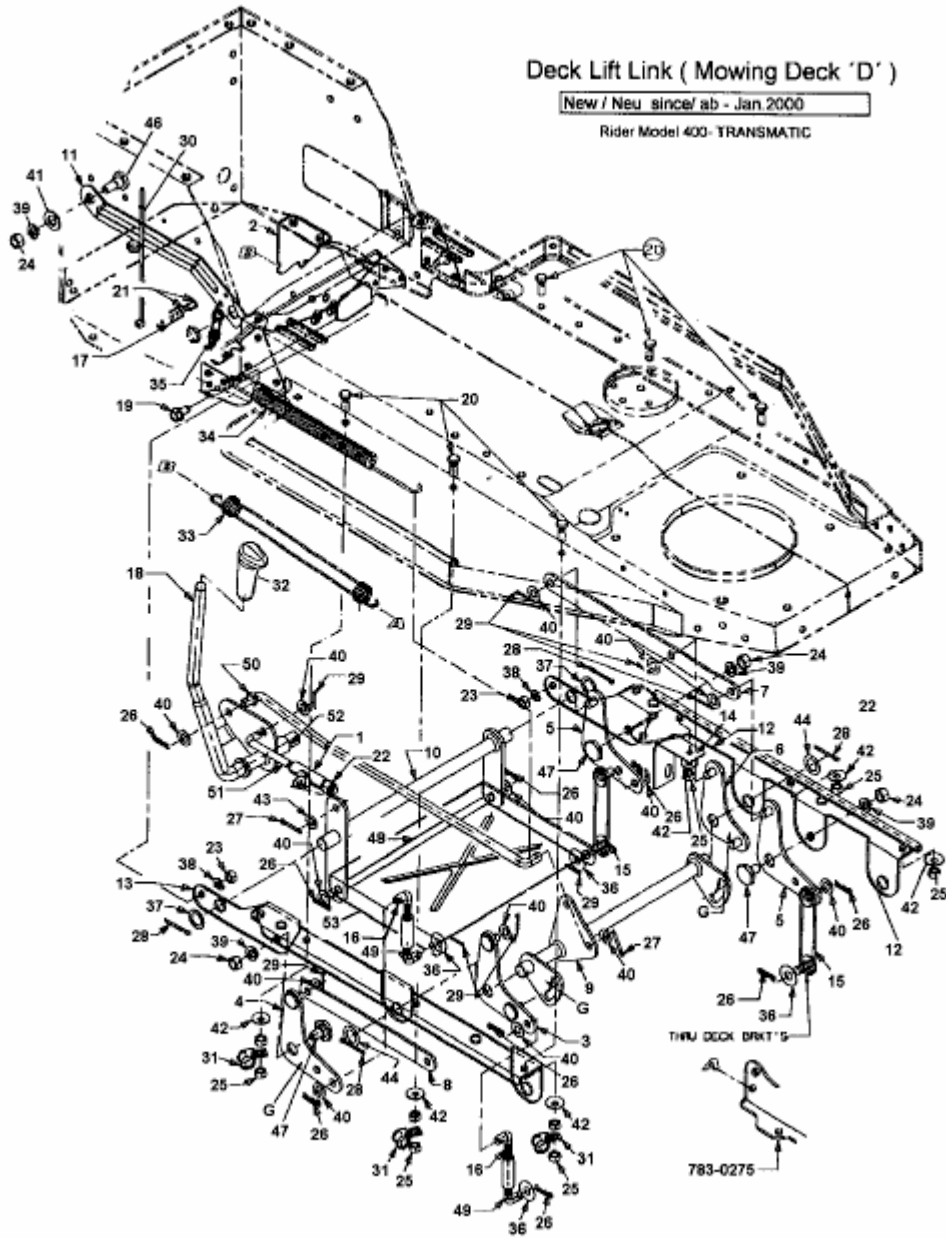

fig

E3-01591A-01