

RH 125/92 > 13A3450E600 (2002) > ARMATURENBRETT, SITZ, TANK

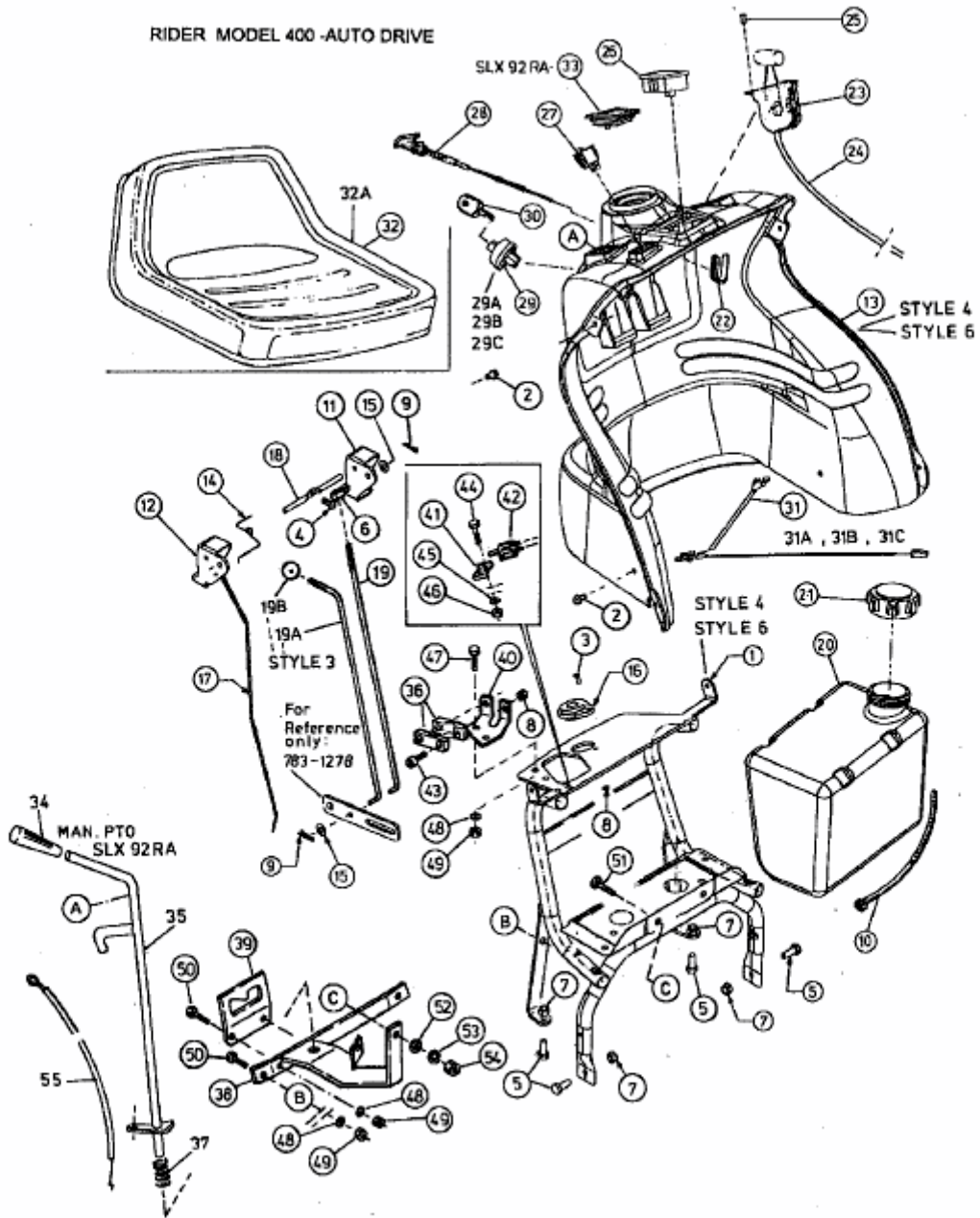

E3-01527 C