

ab 03/01/2018  
from 01/03/2018  
à partir du 03/01/2018

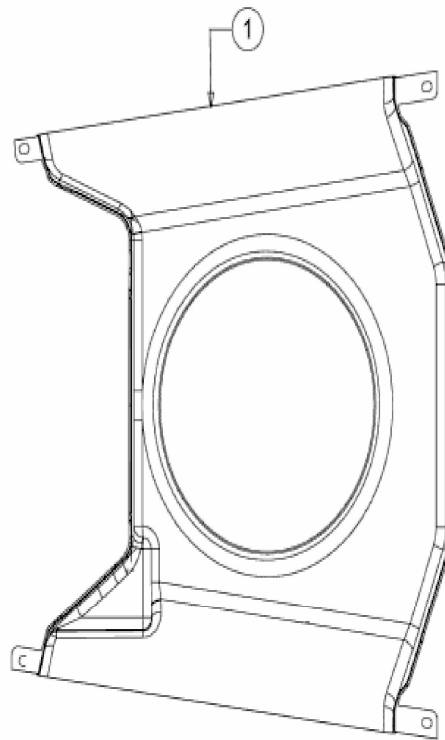

E3-00116A-01