

FWT 135/96 > 13A1768F617 (2007) > MÄHWERKSEINSCHALTUNG, MOTORKEILRIEMENSCHLEIBE

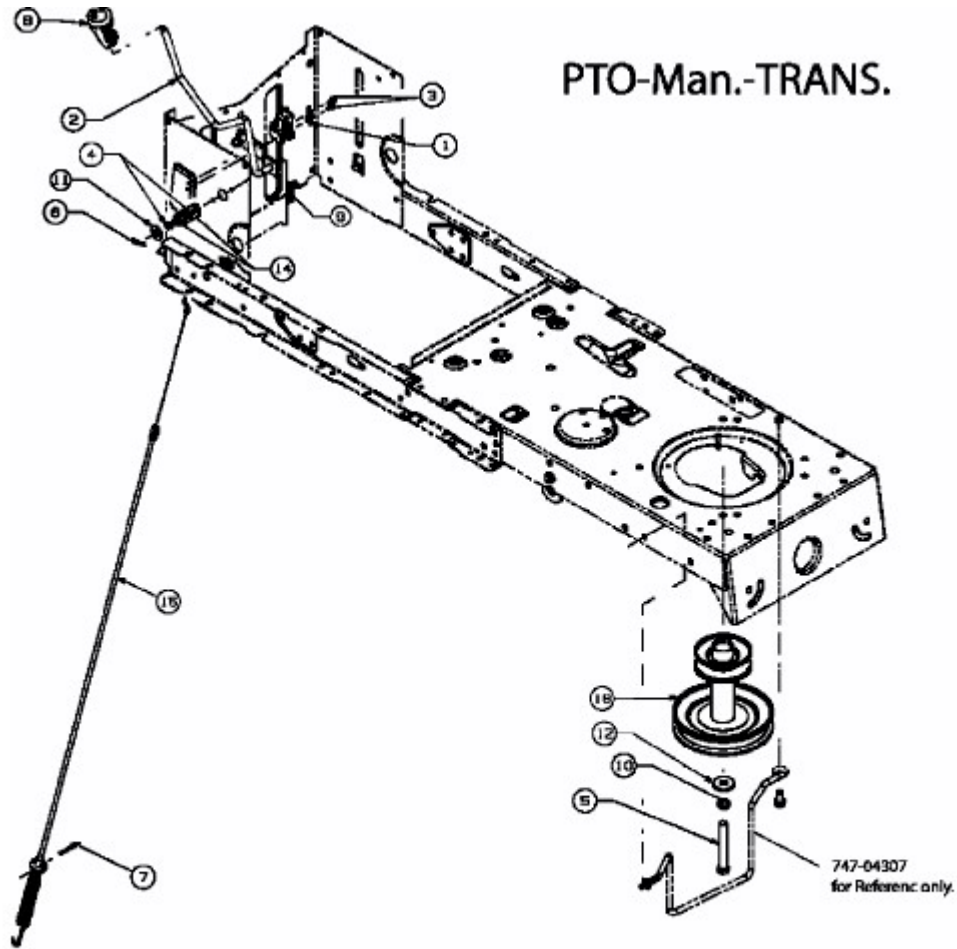

E3-02732B-01