

FWT 135/96 > 13A1768F617 (2007) > FAHRANTRIEB, VARIATOR

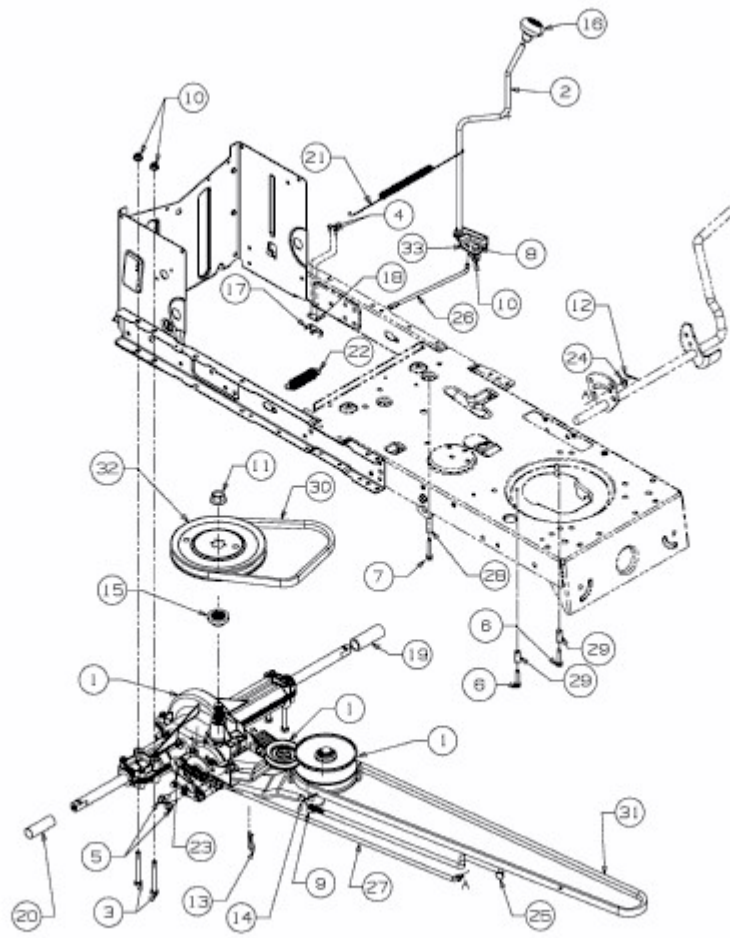

E3-02723B-01