

FWT 135/96 > 13A1768F617 (2006) > GESCHWINDIGKEITSREGELUNG, PEDALE

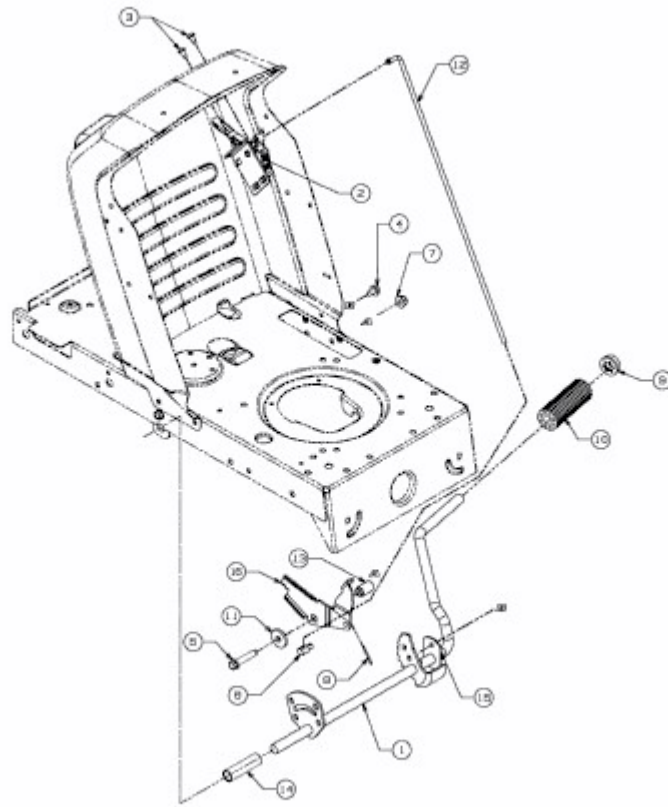

E3-02718A-01