

FWT 135/96 > 13A1768F417 (2007) > RAHMEN

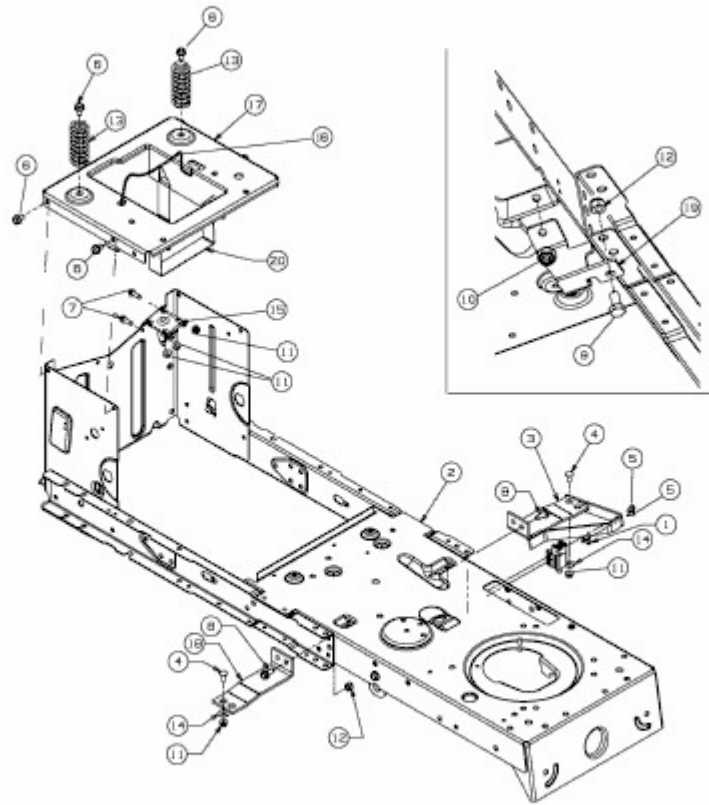

E3-02717B-01