

13.5/38 > 13A1765F308 (2016) > LENKRAD

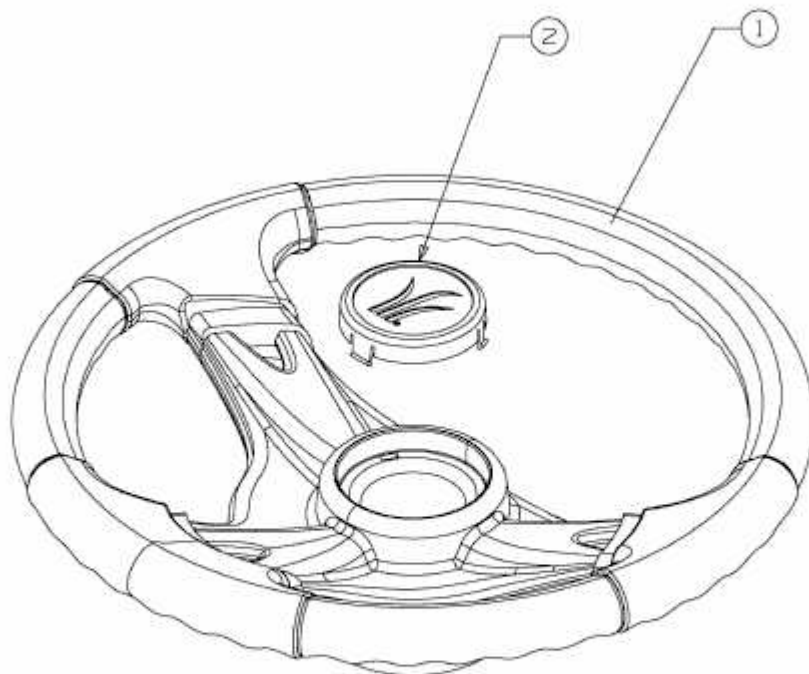

E3-02014B-01