

13.5/38 > 13A1765F308 (2015) > GESCHWINDIGKEITSREGELUNG

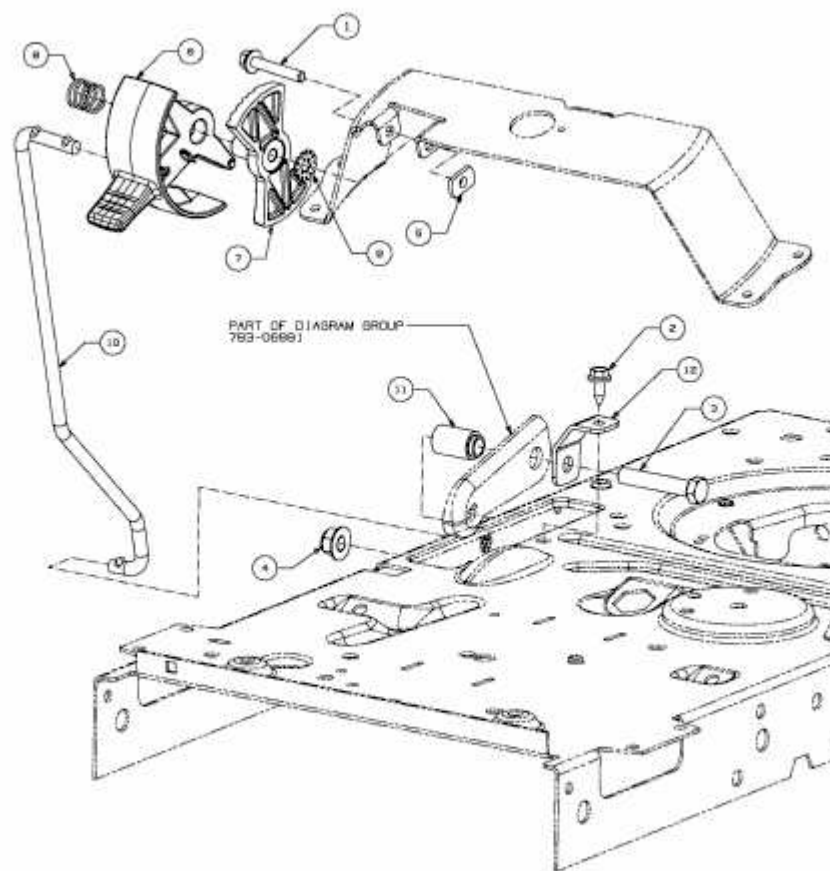

E3-07438B-01