

RS 115/96 > 13A1662F600 (2004) > LENKRAD MIT LOGO

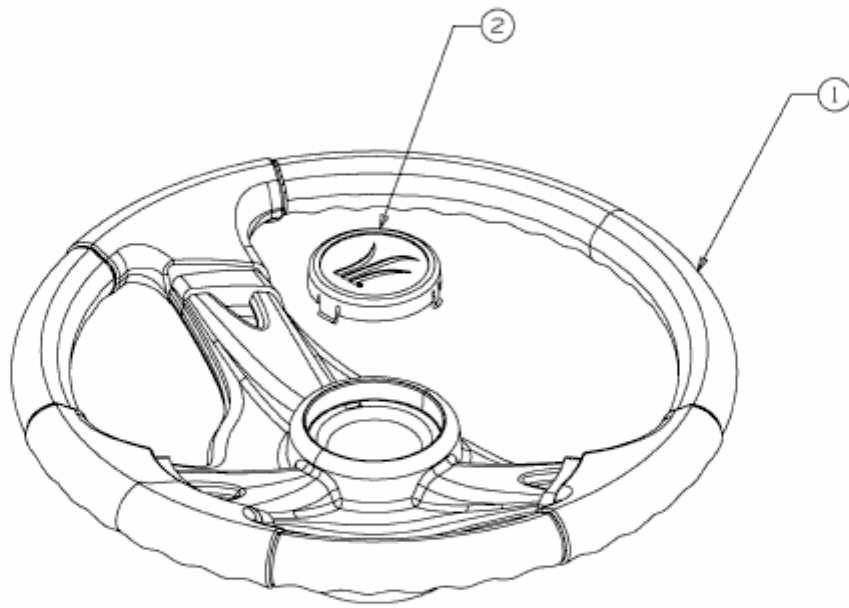

E3-02014A-01