

B 10 > 13A1451D600 (2000) > MOTORZUBEHÖR

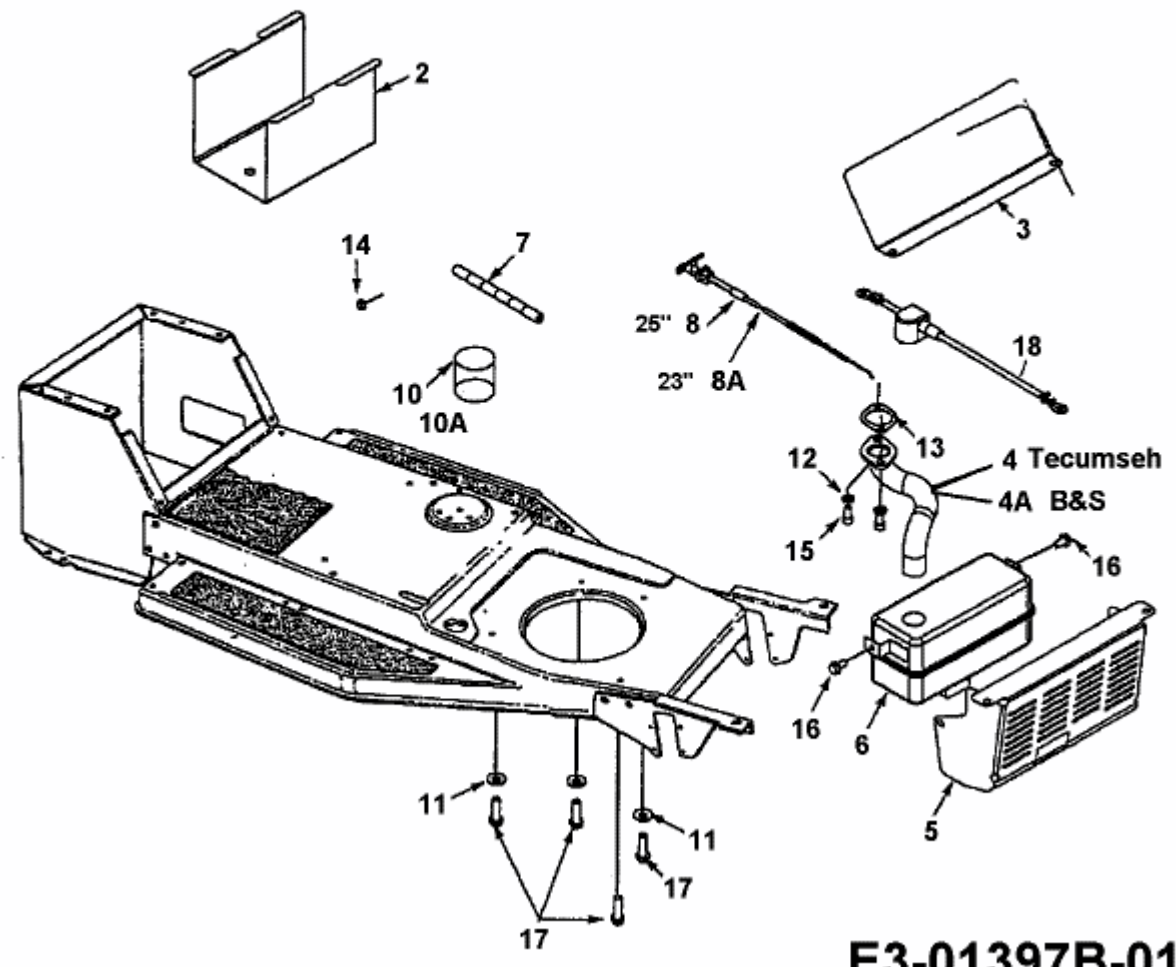

fsg

E3-01397B-01