

B 10 > 13A1451D600 (2000) > MÄHWERKSAUSHEBUNG

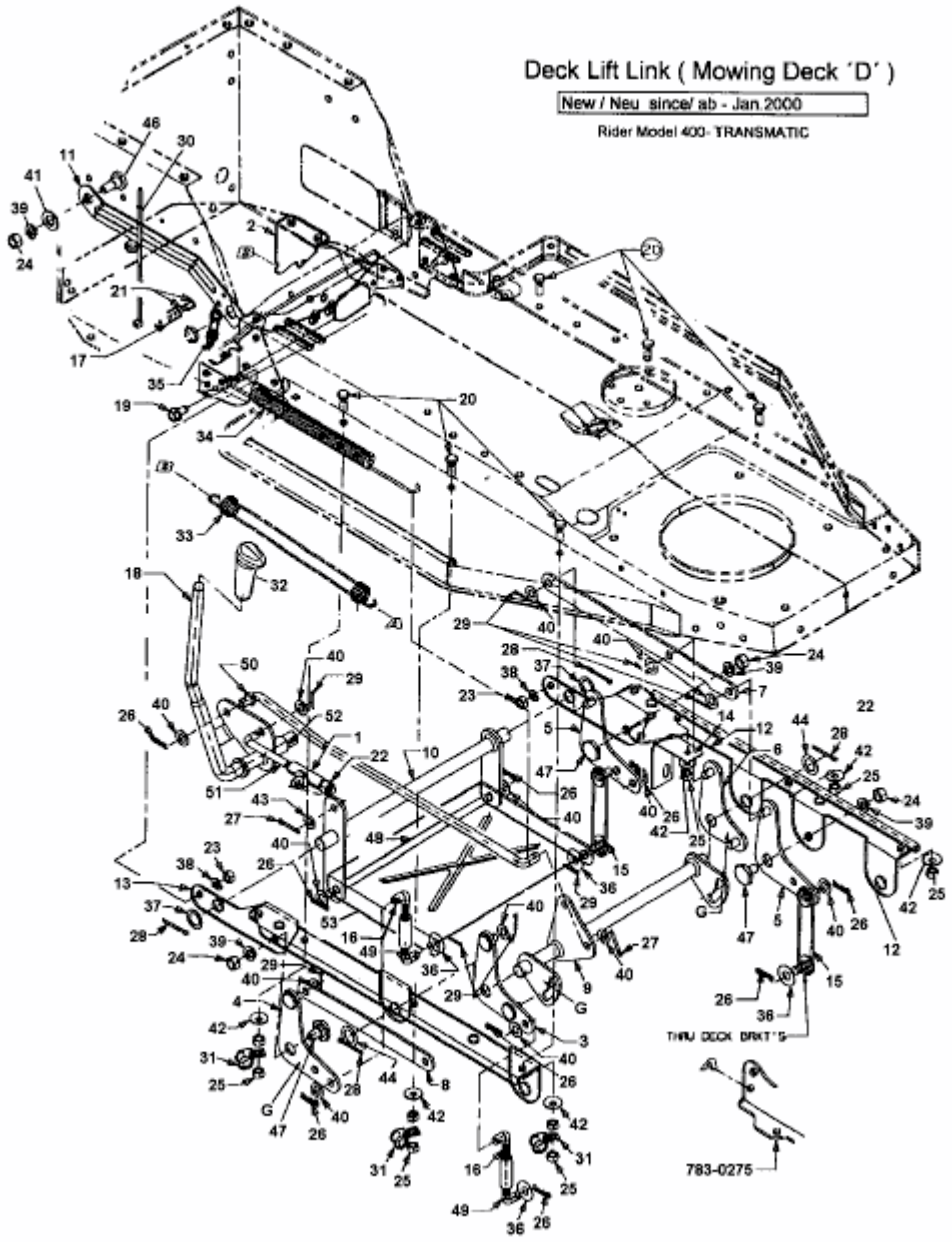

fig

E3-01591A-01