

B 10 > 13A1451D600 (2000) > LENKUNG, RÄDER VORNE, VORDERACHSE

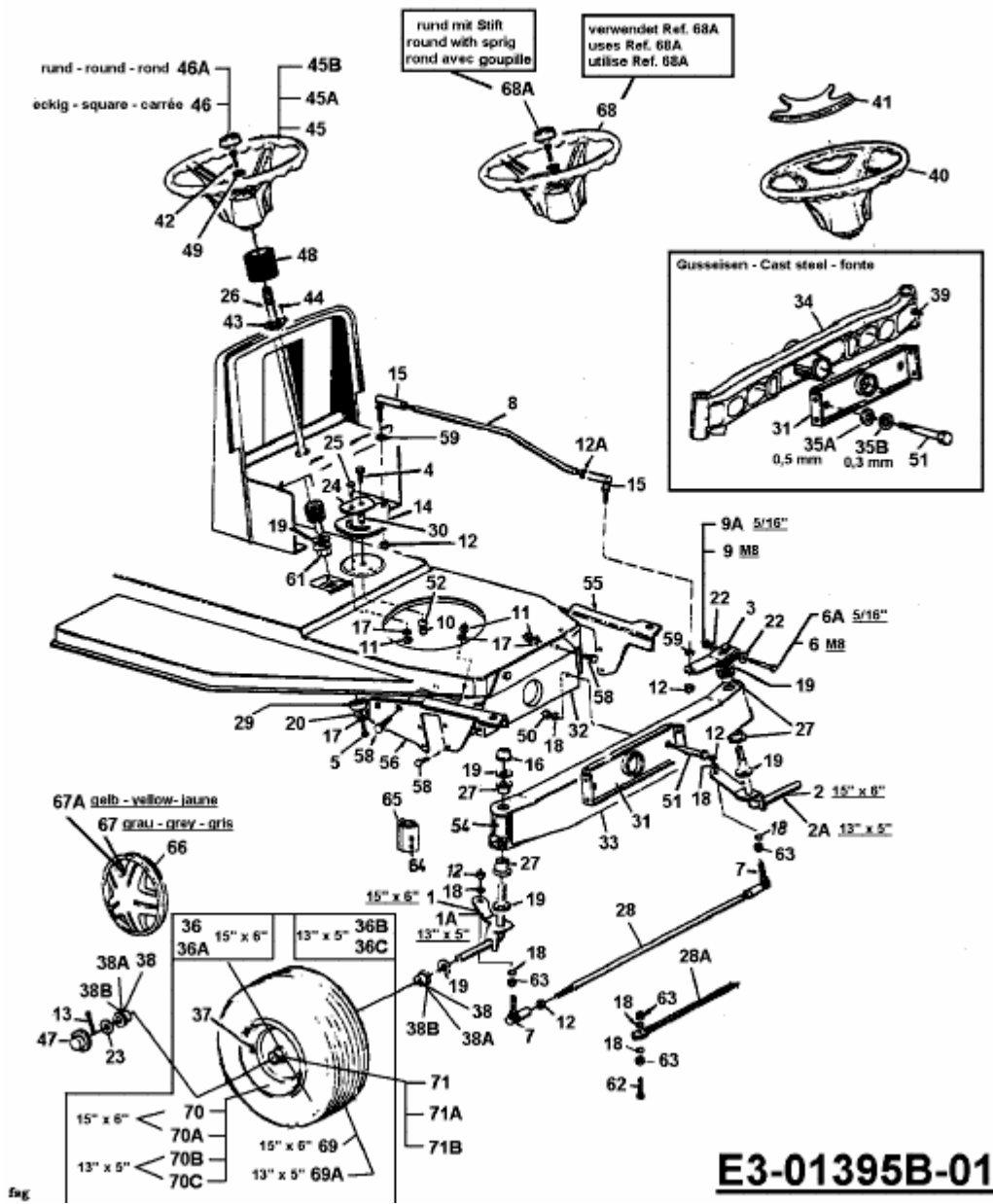

E3-01395B-01