

B 10 > 13A1450D600 (2003) > MOTORZUBEHÖR

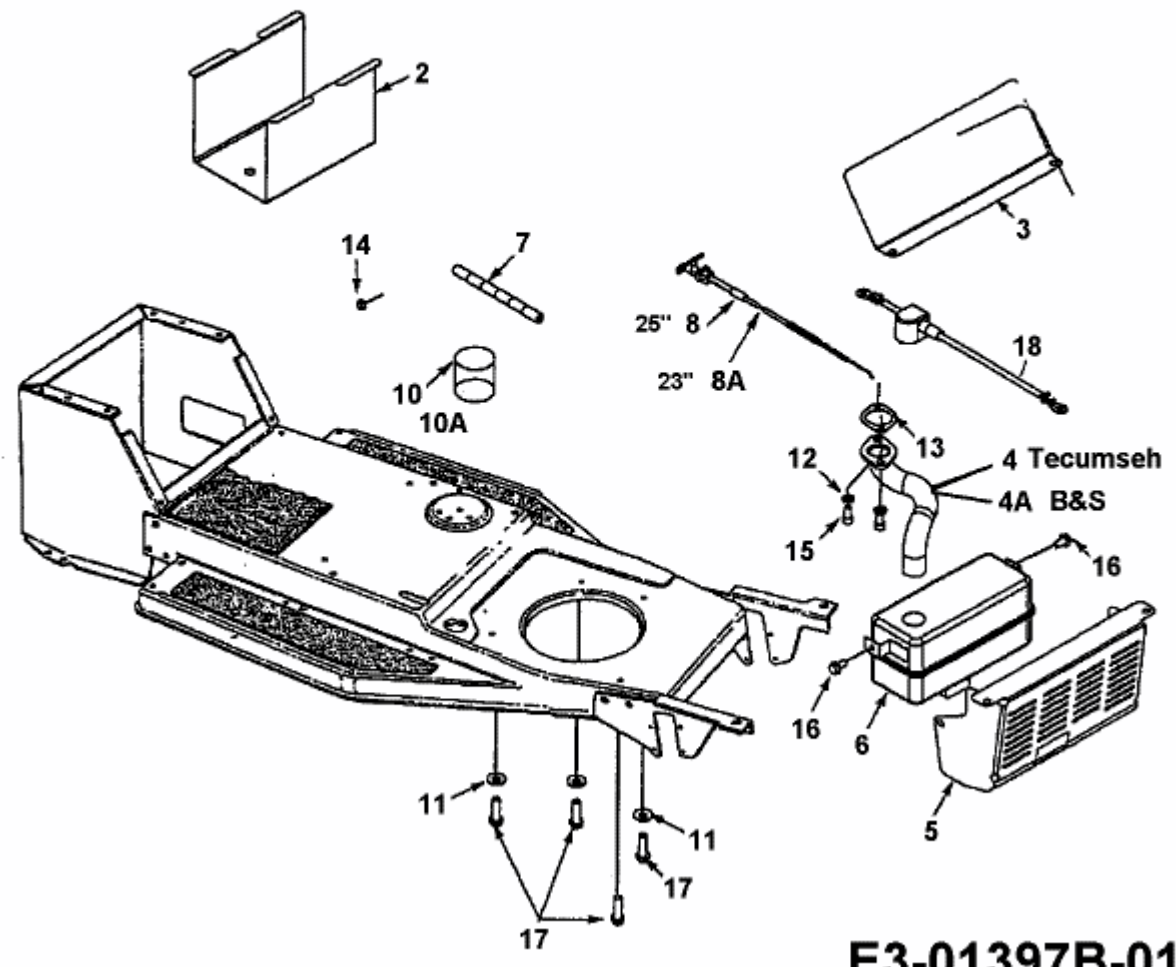

fsg

E3-01397B-01